



ODYSSEY®



Odyssey has been leading the **PRO Audio** and **PRO DJ** industry through innovation for over 23 years. How time flies when you are having fun doing what you love.

We are proud to have brought many firsts to our industry over the years including numerous patented designs such as our **Edge Guard™**, **Glide Style™**, and **Slide Style™** cases as well as our **Black Label™** series cases that give the DJ a more slick and classy look at any gig, and our **Flight FX™** LED series cases that, with their light up panel effects, are perfect for DJs who love to be the center of attention.

Here are just some examples of original designed cases and accessories that we first brought to the DJ market:

Universal DJ cases • Adjustable case-clamping/tabletop Laptop stands • Truss tables with adjustable tabletops • LED back lit compact DJ keyboards • Original Slide Style carpeted and flight cases • original DJ bags • Thermal-lined record/utility bags • Transparent record/utility cases • DJ Facades with dual layered scrim for more even light dispersion • Original space saving Light Columns • The original “DJ” chair • Decorative Face Plates for media players • Red-lined interior DJ bags • DIY racks • LED rack lights • full width glide and dual tier DJ Coffin gear platforms • easy removable V-cut DJ case liftoff doors • low profile compact DJ controller cases • Adjustable 19” rack mount space DJ controller cases • cases with side tables • tripod stands with locking casters for easy speaker positioning • modular DJ trussing systems • and many more...

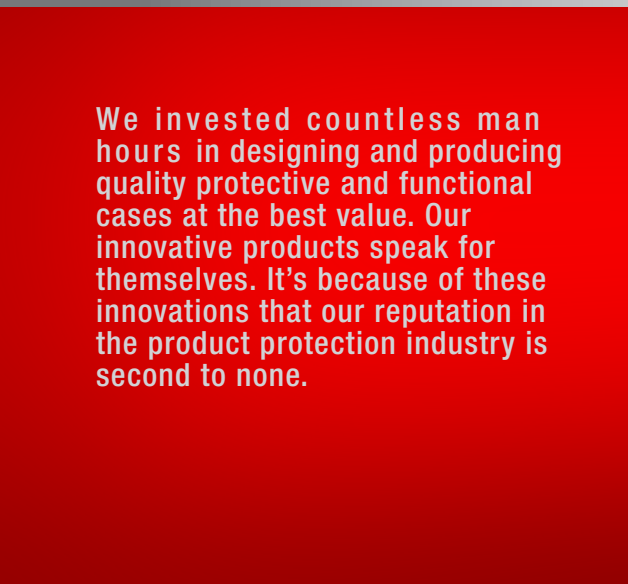

We invested countless man hours in designing and producing quality protective and functional cases at the best value. Our innovative products speak for themselves. It's because of these innovations that our reputation in the product protection industry is second to none.



Most importantly, we value your input and feedback. We sincerely thank you for your continued support. It is what has made us who we are today.

What's in the future? We are committed to continuing our mission statement, **“Leading Through Innovation”**. As from the beginning, providing protective and innovative accessory products for your livelihood is our business and we will continue to do so for years to come.

TABLE OF CONTENTS

DJ CONTROLLER CASES AND BAGS	(1-30)	DESIGNER DJ™ SERIES CASES	(73-74)	VULCAN SERIES INJECTION MOLDED CASES		TURNTABLE CARTRIDGE CASES & BATTLE TRAYS	(170)
FLIGHT FX™ CASES	(1-4)	CD/DIGITAL MEDIA PLAYER CASES	(73)	-WATERTIGHT & DUST-PROOF	(115-120)	L-EVATION HEAVY-DUTY GEAR STANDS	(171-172)
AMERICAN AUDIO CASES	(5)	DJ MIXER & TURNTABLE CASES	(74)	UTILITY CARRYING CASES	(115-117)	LIGHTING STANDS & ACCESSORIES	(174)
DENON CASES	(6-12)			TROLLEY UTILITY CASES	(118)	MOBILE TRUSS SYSTEMS	(175-176)
NATIVE INSTRUMENTS CASES	(13-16)	FLIGHT ZONE® & FLIGHT READY® CASES	(75-111)	UTILITY CASES WITH RECESSED CORNER WHEELS	(119-120)	SPEAKER STANDS ACCESSORIES	(177-179)
NUMARK	(17-23)	TURNTABLE DJ COFFINS - STANDARD	(75)			CRANK-UP STANDS & ACCESSORIES	(180-183)
PIONEER CASES	(24-36)	CD/DIGITAL MEDIA DJ COFFINS		CARPETED CASES & RACKS	(121-131)	HALO DJ TRUSS SYSTEMS	(183-184)
RELOOP CASES	(37)	-STANDARD & GLIDE STYLE™	(76-79)	DJ COFFINS – STANDARD & GLIDE STYLE™		PAR LIGHTING FIXTURES	(185-186)
ROLAND CASES	(37-38)	CD/DIGITAL MEDIA DJ COFFINS		TURNTABLE CASES	(121-122)	PRO LIGHTING CLAMPS	(187-189)
UNIVERSAL CASES™ FLIGHT READY® SERIES	(39-40)	- GSX GLIDE STYLE™	(80)	AMP RACKS - STANDARD & PRO SERIES	(123-124)	ODY SHIELDS UPLIGHT DÉCOR PACKAGES	(190)
UNIVERSAL CASES™ FLIGHT ZONE® SERIES	(41)	CD/DIGITAL MEDIA & TURNTABLE DJ COFFINS - REMIXER™ GLIDE STYLE™ SERIES	(81-82)	COMBO RACKS - PRO & CXC SERIES	(125)	MOBILE VIDEO SCREEN SYSTEMS & ACCESSORIES	(191-192)
UNIVERSAL CASES™ BLACK KROM™ SERIES	(42)	TURNTABLE DJ COFFINS - GLIDE STYLE™	(83)	COMBO RACKS - CXP SERIES	(126)	VIDEO PROJECTION STRETCH SCREENS	
REDLINE™ SERIES BAGS	(43-47)	CD/5" MEDIA DISC & VINYL RECORD / UTILITY CASES	(84)	COMBO RACKS - CXC SERIES & SLIDE STYLE™ SERIES	(127)	- SCRIM WERKS™	(193)
REMIX MK2™ SERIES BAGS	(48-50)	TURNTABLE CASES	(85)	COMBO RACKS - LAPTOP SLIDE STYLE™ SERIES	(128)	X-STAND COVER SLIP SCREENS™	
STREEMLINE SERIES EVA BAGS	(51-52)	DJ MIXER CASES - STANDARD & GLIDE STYLE™	(86-87)	STUDIO RACKS	(129)	- SCRIM WERKS™	(194)
		CD/DIGITAL MEDIA MIXER CASE	(88)	CD/5" MEDIA DISC CASES	(130)	LIGHT COLUMNS & ACCESSORIES	
FLIGHT FX™ CASES & ACCESSORIES	(53-58)	CD/DIGITAL MEDIA PLAYER CASES	(89)	VINYL RECORD / UTILITY CASES	(131)	- SCRIM WERKS™	(195-198)
CD/DIGITAL MEDIA DJ COFFINS - STANDARD	(53)	EFFECTS RACKS	(90)			MOLDED SPEAKER COVER SLIP	
TURNTABLE DJ COFFINS - STANDARD	(54)	AMP RACKS	(91)	KROM™ CASES	(133-136)	SCREENS™- SCRIM WERKS™	(198)
CD/DIGITAL MEDIA DJ COFFINS - GLIDE STYLE™	(55)	SHOCK MOUNT RACKS	(92)	BLACK KROM™ SERIES CASES	(133-134)	TRUSS SLEEVE COVER SLIP SCREENS™- SCRIM WERKS™	(199)
TURNTABLE DJ COFFINS - GLIDE STYLE™	(55)	SPACE SAVER AMP & COMBO RACKS - STANDARD	(93)	CD/5" MEDIA DISC CASES	(135)	DJ FACADES - SCRIM WERKS™	(200-203)
CD/DIGITAL MEDIA PLAYER CASES	(56)	COMBO RACKS - STANDARD & GLIDE STYLE™	(94-95)	VINYL RECORD / UTILITY CASES	(136)	DÉCOR PANELS & ACCESSORIES - SCRIM WERKS™	(204)
TURNTABLE CASES	(57)	MICROPHONE CASES	(96)	REDLINE™ SERIES & OTHER BAGS	(138-144)	TRIPOD & TRIANGULAR SCRIMS - SCRIM WERKS™	(205-206)
DJ MIXER CASES - STANDARD & GLIDE STYLE™	(58)	GUITAR COMBO AMP CASES	(97)	DIGITAL GEAR BACKPACKS	(138)	15' HIGH CRANK STAND SLIP SCREENS™	
FLIGHT FX™ CASE ACCESSORIES	(58)	GUITAR AMP HEAD & SPEAKER CABINET CASES	(98)	MOBILE TRIPOD SYSTEM WHEELED TOTE BAG	(138)	- SCRIM WERKS™	(207)
		GUITAR PEDAL BOARD CASES	(99)	LIGHTING / UTILITY GEAR BAGS	(139)	TABLE SLIP SCREENS™ - SCRIM WERKS™	(208)
BLACK LABEL™ SERIES CASES & ACCESSORIES	(59-72)	KEYBOARD CASES & COVERS	(100)	SPEAKER BAGS	(140)	PHOTO BOOTH PRINTER CASES, BAG, & ACCESSORIES	(209-211)
CD/DIGITAL MEDIA DJ COFFINS - STANDARD	(59-60)	LIVE SOUND MIXER CONSOLE CASES	(101-102)	DIGITAL GEAR TROLLEY BAGS	(141-143)	PORTABLE BENCHES & MUSICIAN/DJ CHAIRS	(212-213)
TURNTABLE DJ COFFINS - STANDARD & GLIDE STYLE™	(60-61)	PAR / LIGHTING / UTILITY CASES	(103)	HEADPHONES / UTILITY POUCHES	(144)	RACK ACCESSORIES	(214-216)
CD/DIGITAL MEDIA PLAYER DJ COFFINS-GLIDE STYLE™	(61-62)	DUAL MOVING HEAD CASES	(104)	RACK BAGS	(145)		
CD/DIGITAL MEDIA PLAYER DJ COFFINS - GSX GLIDE STYLE™	(62)	CHAUVET GEYSER CASE	(105)	MISCELLANEOUS ACCESSORIES	(146-218)		
CD/DIGITAL MEDIA & TURNTABLE DJ COFFINS - REMIXER™		RACK MOUNT LIGHTING CONTROLLER CASES	(105)	MOVING EQUIPMENT - DOLLY PLATES / ROCK N ROLLER MULITI-CARTS®	(146-148)		
GLIDE STYLE™ SERIES	(63-64)	FLAT SCREEN MONITOR CASES	(106-107)	COMPACT BACKLIT LED KEYBOARDS	(149-150)		
CD/DIGITAL MEDIA PLAYER & TURNTABLE CASES	(65-66)	STAKPAK™ UTILITY CASES	(108)	FOLD-OUT STANDS - CARPETED & FLIGHT ZONE®	(151-152)		
DJ MIXER CASES - STANDARD & GLIDE STYLE™	(66-67)	UTILITY TRUNK TRUCK PACKS	(109-110)	X-STANDS	(153-154)		
FOLD-OUT STANDS	(68)	PLUCK FOAM UTILITY CARRYING CASES	(111)	DJ TABLES - TRUSS & CARPETED	(155-156)		
AMP RACKS	(69)	CUSTOM CASES	(112-114)	6"x 6" NEXUS DJ TRUSS SYSTEMS & ACCESSORIES	(157-161)		
COMBO RACKS - STANDARD & GLIDE STYLE™	(70-71)	CADILLAC ROAD CASES/LIGHTING CASES	(112)	8"X8" NEXUS FOLDING DJ TRUSS SYSTEM & ACCESSORIES	(162-163)		
UTILITY / TRUCK PACKS CASES	(72)	MOVING HEAD LIGHT CASES	(112)	10"X10" NEXUS DJ TRUSS SYSTEM AND ACCESSORIES	(164)		
		MOTOR CASES / WORKBOXES / DRAWER CASES	(112)	L STANDS AND ACCESSORIES	(165-169)		
		CUSTOM FOAM INSERTS	(114)				

Disclaimer: Odyssey Innovative Designs strives to ensure the accuracy of the information contained herein. However, due to the constant change in raw materials available and used, improvements in design, typographical errors, and other factors may be beyond our control. We reserve the right to make changes in designs, styles, features, colors, dimensions, and other specifications without prior notice. Copyrighted logos and trademarks are those of the respective company: Akai, Alesis, Allen & Heath, American Audio, Apple, Avertac, B-52, BBE, Behringer, Boss, Cascio, Chauvet, Coemar, Cortex, Crown, Dell, Denon, Digidesign, Drawmer, Elation, Fender, Gemini, Gemsound, Gibson, Hercules, Korg, M-Audio, Mackie, Marshall, Martin, Mesa, Multi-Cart, Native Instruments, Numark, Ortofon, Pearl River, Peavey, Pioneer, Rane, Reeloc, Robe, Roland, Serato, Shure, Sony, Soundcraft, Tascam, Technics, Traktor Scratch, Vestax, Vox, Yamaha, etc. Equipment pictured not included. Actual product weights may vary.

CONTROLLER CASES

For the past two decades, Odyssey has led and continues to be the leader in the professional DJ industry by pioneering protective gear solutions. The tradition continues with Odyssey's full-line of diverse, high quality patented DJ controller cases, specifically custom designed for today's most popular brands and models on the market. Odyssey, providing DJ'S the ultimate solutions. A company you can trust to ensure premium fit and fuction.

NATIVE INSTRUMENTS TRAKTOR CONTROL S4/S5/F1/X1 FRONT LED PANEL FFXGSTKS4FX1W

- Flight FX™
- Glide Style™
- Glide Tray™
- fits Native Instruments Traktor Kontrol S4/S5/F1/X1
- 36" x 10" x 22.5" 50 lbs.



FLIGHT FX
LED panel series
*China Patented. U.S. and Other Foreign Patents Pending



- Front 7 Color-Changing LED Panel with Controller(linkable to other FX cases)
- LED panel Effects:
 - (1) Set to 1 Color or Random Color Changing,
 - (2) Slow Flashing Color Changing,
 - (3) Fast Flashing Color Changing,
 - (4) Auto Color Mixing Fade in Fade out,
 - (5) Sound Activated

*Control SL keyboard, Traktor Kontrol S4, Macbook and other gear not included
**removable front panel not shown



NUMARK NS7II GLIDE PLATFORM & FRONT LED PANEL FFXGNS7IIX1BL

- Flight FX™
- Glide Style™
- Black Label™
- fits Numark NS7/NS7II
- 1U bottom rack
- 36.25" x 11.5" x 23.5" 46 lbs.



Top view with Glide Platform removed





LED panel series
 *China Patented. U.S. and Other
 Foreign Patents Pending

**PIONEER DDJ-RX/SX2
 FRONT LED PANEL
 FFXGSPIDDJSXBL**

- Flight FX™
- Glide Style™
- Black Label™
- fits Pioneer DDJ-RX/S1/SX/SX2/T1
- 32" x 8.75" x 19.25" 29 lbs.



**PIONEER DDJ-RX/S2
 GLIDE PLATFORM
 & FRONT LED PANELS
 FFXGSPIDDJSX2BL**

- Flight FX™
- Glide Style™
- Black Label™
- fits Pioneer DDJ-RX/SX/SX2
- 1U bottom rack
- 31" x 9.5" x 19" 30 lbs.

**PIONEER DDJ-RX/SX2
 FRONT LED PANEL
 FFXGSPDDJSXGTBL**

- Flight FX™
- Glide Style™
- Glide Tray™
- Black Label™
- fits Pioneer DDJ-RX/SX/SX2/S1/T1
- 32" x 9.5" x 19" 39 lbs.



**BOTTOM
 PULLOUT
 GLIDE TRAY
 SHELF**



**PIONEER DDJ-RZ/SZ2
 GLIDE PLATFORM & FRONT LED PANEL
 FFXGSPIDDJSZWBL**

- Glide Style™
- Black Label™
- fits Pioneer DDJ-RZ/SZ/SZ2
- 1U bottom rack
- 37.5" x 10.75" x 25" 47 lbs.



AMERICAN AUDIO VMS5 CONTROLLER CASES



AMERICAN AUDIO VMS5

FRVMS5BL

- Black Label™
- fits American Audio VMS4 / VMS4.1 / VMS5
- 21.75" x 7.25" x 19.25" 13 lbs.



AMERICAN AUDIO VMS5

FRVMS5

- fits American Audio VMS4 / VMS4.1 / VMS5
- 21.75" x 7.25" x 19.25" 13 lbs.



AMERICAN AUDIO VMS5

FZGSTKS4

- Glide Style™
- fits Native Instruments Traktor Kontrol S4/S4MK2/S5, American Audio VMS4/VMS4.1/VMS5, Numark IDJ3, Mixtrack Pro
- 24.5" x 8.75" x 18.25" 23 lbs.



AMERICAN AUDIO VMS5

FZGSTKS4BL

- Glide Style™
- Black Label™
- fits Native Instruments Traktor Kontrol S4/S4MK2/S5, American Audio VMS4/VMS4.1/VMS5, Numark IDJ3, Mixtrack Pro
- 24.5" x 8.75" x 18.25" 23 lbs.

DENON DN-MC4000 CONTROLLER CASES

DENON DN-MC4000

FRDNMC4000BL

- Black label™
- Low Profile
- fits Denon DN-MC4000
- 23.75" x 6.5" x 17.25" 13 lbs



DENON DN-MC4000

FRDNMC4000

- Low Profile
- fits Numark Denon DN-MC4000
- 23.75" x 6.5" x 17.25" 13 lbs

DENON DN-MC4000

FRDNMC4000S

- Bottom Laptop compartment
- fits Numark Denon DN-MC4000
- 24.75" x 7" x 17.5" 15 lbs



DENON DN-MC4000

FRDNMC4000SBL

- Black label™
- Bottom Laptop compartment
- fits Denon DN-MC4000
- 24.75" x 7" x 17.5" 15 lbs

DENON DN-MC4000 CONTROLLER CASES



DENON DN-MC4000
FRGSDNMC4000

- Low Profile
- Glide Style™
- fits Denon DN-MC4000
- 24.75" x 7" x 17.25" 20 lbs



DENON DN-MC4000
FRGSDNMC4000BL

- Black Label™
- Low Profile
- Glide Style™
- fits Denon DN-MC4000
- 24.75" x 7" x 17.25" 20 lbs



DENON DN-MC4000
FZGSMC4000BL

- Black Label™
- Glide Style™
- fits Denon DN-MC4000
- 24.5" x 8.75" x 18.25" 26 lbs



DENON DN-MC4000
FZGSMC4000

- Glide Style™
- fits Denon DN-MC4000
- 24.5" x 8.75" x 18.25" 26 lbs

DENON DN-MC6000 MK2 CONTROLLER CASES



DENON DN-MC6000 MK2
FRDNMC36000BL

- Black Label™
- fits Denon DN-MC3000/6000 MK2
- 21.25" x 7.75" x 16.75" 15 lbs.



DENON DN-MC6000 MK2
FRDNMC36000

- fits Denon DN-MC3000/6000 MK2
- 21.25" x 7.75" x 16.75" 15 lbs.



DENON DN-MC6000 MK2
FRGSDNMC36000

- Glide Style™
- fits Denon DN-MC3000/6000 MK2
- 23.25" x 8.75" x 16.75" 21 lbs.



DENON DN-MC6000 MK2
FRGSDNMC36000BL

- Black Label™
- Glide Style™
- fits DN-MC3000/6000 MK2
- 23.25" x 8.75" x 16.75" 21 lbs.



DENON DN-MC6000 MK2
FRGSDNMC36000GT

- Glide Style™
- Glide Tray™
- fits Denon DN-MC3000/6000 MK2
- 23" x 9" x 16.75" 23 lbs.



DENON MC7000 **NEW**
FRGSMC7000
• Glide Style™
• fits Denon MC7000
• 30.5" x 9.5" x 22.75" 40 lbs.



DENON MC7000 **NEW**
FRMC7000
• fits Denon MC7000
• 29.5" x 9.5" x 22.5" 28 lbs.



DENON MC7000
FZGSDJ808W2
• Glide Style™
• fits Denon MC7000, Pioneer DDJ-RX/SX/SX2, Roland DJ-808
• 2U bottom rack
• 32" x 11.5" x 22" 42 lbs.



DENON MC7000
FZGSDJ808W2BL
• Black label™
• Glide Style™
• fits Denon MC7000, Pioneer DDJ-RX/SX/SX2, Roland DJ-808
• 2U bottom rack
• 32" x 11.5" x 22" 50 lbs.

DENON MCX8000 CONTROLLER CASES



- DENON MCX8000**
CDNMCX8000
- Carpeted
 - Fits Denon MCX8000
 - 32"x 5.75"x 21.5" 20 lbs.



- DENON MCX8000**
FZDNMCX8000
- Low Profile
 - Fits Denon MCX8000
 - 31.75"x 7.75"x 22" 25 lbs.



- DENON MCX8000**
FZDNMCX8000BL
- Low Profile
 - Black Label™
 - Fits Denon MCX8000
 - 31.75"x 7.75"x 22" 25 lbs.



DENON MCX8000 CONTROLLER CASES

- DENON MCX8000**
FZGSMCX8000W2BL
- Black Label™
 - Glide Style™
 - 2U Rack Spaces
 - fits Denon MCX8000
 - 34.25" x 2.25" x 22.5" 42 lbs.



- DENON MCX8000**
FZGSMCX8000W2
- Glide Style™
 - 2U Rack Spaces
 - Fits Denon MCX8000
 - 34.25" x 2.25" x 22.5" 42 lbs.



NATIVE INSTRUMENTS MASCHINE STUDIO, TRAKTOR KONTROL S2 MK2 CONTROLLER CASES

NATIVE INSTRUMENTS MASCHINE STUDIO FZGSMASCHINES

- Glide Style™
- fits Native Instruments Maschine Studio
- 23" x 8.25" x 19" 23 lbs.



NATIVE INSTRUMENTS MASCHINE STUDIO FZGSMASCHINESBL

- Black Label™
- Glide Style™
- fits Native Instruments Maschine Studio
- 23" x 8.25" x 19" 23 lbs.



NATIVE INSTRUMENTS TRAKTOR KONTROL S2 MK2 FZGSTKS2

- Glide Style™
- fits Native Instruments Traktor Kontrol S2 MK2
- 23.5" x 9" x 17" 21 lbs.



NATIVE INSTRUMENTS TRAKTOR KONTROL S2 MK2 FZGSTKS2BL

- Black Label™
- Glide Style™
- fits Native Instruments Traktor Kontrol S2 MK2
- 23.5" x 9" x 17" 21 lbs.



NATIVE INSTRUMENTS TRAKTOR KONTROL S4 MK2/S5 FRTS4

- fits Native Instruments Traktor Kontrol S4 / S4 MK2 / S5
- 22.625" x 7.25" x 19" 13 lbs.



NATIVE INSTRUMENTS TRAKTOR KONTROL S4 MK2/S5 CONTROLLER CASES

NATIVE INSTRUMENTS TRAKTOR KONTROL S4 MK2/S5 FRTS4BL

- Black Label™
- fits Native Instruments Traktor Kontrol S4 / S4 MK2 / S5
- 22.625" x 7.25" x 19" 13 lbs.



NATIVE INSTRUMENTS TRAKTOR KONTROL S4 MK2/S5 FZGSTKS4

- Glide Style™
- fits Native Instruments Traktor Kontrol S4/S4MK2/S5, American Audio VMS4/VMS4.1/VMS5, Numark IDJ3, Mixtrack Pro
- 24.5" x 8.75" x 18.25" 23 lbs.



NATIVE INSTRUMENTS TRAKTOR KONTROL S4 MK2/S5 FZGSTKS4BL

- Glide Style™
- Black Label™
- fits Native Instruments Traktor Kontrol S4/S4MK2/S5, American Audio VMS4/VMS4.1/VMS5, Numark IDJ3, Mixtrack Pro
- 24.5" x 8.75" x 18.25" 23 lbs.



NATIVE INSTRUMENTS TRAKTOR KNOTROL S4 MK2 / S5 CONTROLLER CASES



NATIVE INSTRUMENTS TRAKTOR KONTROL S4 MK2 / S5

FZTKS5

- Low Profile
- fits Native Instruments Traktor Kontrol S4 / S4 MK2 / S5
- 23.25"W x 6.75"H x 18.75"D 14 lbs.



NATIVE INSTRUMENTS TRAKTOR KONTROL S4 MK2 / S5

FZTKS5BL

- Low Profile
- Black Label™
- fits Native Instruments Traktor Kontrol S4 / S4 MK2 / S5
- 23.25"W x 6.75"H x 18.75"D 14 lbs..



NATIVE INSTRUMENTS TRAKTOR KONTROL S4 MK2 / S5

FZGSTKS5

- Low Profile
- Glide Style™
- fits Native Instruments Traktor Kontrol S4 / S4 MK2 / S5
- 24.75"W x 7.25"H x 18.75"D 20 lbs



NATIVE INSTRUMENTS TRAKTOR KONTROL S4 MK2 / S5

FZGSTKS5BL

- Low Profile
- Black Label™
- Glide Style™
- fits Native Instruments Traktor Kontrol S4 / S4 MK2 / S5
- 24.75"W x 7.25"H x 18.75"D 20 lbs

NATIVE INSTRUMENTS TRAKTOR KONTROL S8 CONTROLLER CASES

NATIVE INSTRUMENTS TRAKTOR KONTROL S8 FZTKS8

- Low Profile
- fits Native Instruments Traktor Kontrol S8
- 26.75" x 6.5" x 20" 17 lbs.



NATIVE INSTRUMENTS TRAKTOR KONTROL S8 FZTKS8BL

- Low Profile
- Black Label™
- fits Native Instruments Traktor Kontrol S8
- 26.75" x 6.5" x 20" 17 lbs.



NATIVE INSTRUMENTS TRAKTOR KONTROL S8 FZGSTKS8

- Glide Style™
- fits Native Instruments Traktor Kontrol S8
- 27.75" x 9" x 20" 25 lbs.



NATIVE INSTRUMENTS TRAKTOR KONTROL S8 FZGSTKS8BL

- Black Label™
- Glide Style™
- fits Native Instruments Traktor Kontrol S8
- 27.75" x 9" x 20" 25 lbs.



NUMARK MIXDECK QUAD CONTROLLER CASES

NUMARK MIXDECK EXPRESS CONTROLLER CASES

NUMARK MIXDECK QUAD FZMIXDECK

- fits Numark Mixdeck/Mixdeck Quad
- 28.75" x 9.25" x 18.5" 25 lbs.



NUMARK MIXDECK QUAD FZMIXDECKBL

- Black Label™
- fits Numark Mixdeck/Mixdeck Quad
- 28.75" x 9.25" x 18.5" 25 lbs.



NUMARK MIXDECK EXPRESS FRMIXDECKEXS

- fits Numark Mixdeck Express
- 24.75" x 7" x 17.5" 15 lbs.



NUMARK MIXDECK EXPRESS FZMIXDECKEXBL

- Black Label™
- fits Numark Mixdeck Express
- 24.5" x 8" x 24.5" 19 lbs.



NUMARK MIXDECK QUAD FZGSMIXDECKGT

- Glide Style™
- Glide Tray™
- fits Numark Mixdeck/Mixdeck Quad
- 30.5" x 11.5" x 18.75" 39 lbs.



NUMARK MIXDECK QUAD FZGSMIXDECKGTBL

- Glide Style™
- Black Label™
- Glide Tray™
- fits Numark Mixdeck/Mixdeck Quad
- 30.5" x 11.5" x 18.75" 39 lbs.



NUMARK MIXDECK EXPRESS FZGSMIXDECKEX

- Glide Style™
- fits Numark Mixdeck Express
- 24.5" x 8.75" x 18.25" 23 lbs.



NUMARK MIXDECK EXPRESS FZGSMIXDECKEXBL

- Glide Style™
- Black Label™
- fits Numark Mixdeck Express
- 24.5" x 8.75" x 18.25" 23 lbs.



NUMARK NS6II **NEW**
FRNS6II

- Low Profile
- fits Numark NS6II
- 25.75" x 6.5" x 18.5" 15 lbs.



NEW
NUMARK NS6II
FRNS6II

- Low Profile
- fits Numark NS6II
- 25.75" x 6.5" x 18.5" 15 lbs.

NEW **NUMARK NS6II**
FZGSNS6II

- Low Profile
- fits Numark NS6II
- 26.5" x 7" x 18.5" 20 lbs.



NEW **NUMARK NS6II**
FZGSNS6IIBL

- Low Profile
- fits Numark NS6II
- 26.5" x 7" x 18.5" 20 lbs.



NUMARK MIXTRACK 3/MIXTRACK PRO 3 MIXTRACK PLATINUM CONTROLLER CASES

NUMARK MIXTRACK 3/MIXTRACK PRO 3/ MIXTRACK PLATINUM

FRMIXTRACK3

- Low Profile
- fits Numark Mixtrack 3 / Pro 3 / Platinum
- 24.75" x 6.5" x 14.5" 13 lbs.



NUMARK MIXTRACK 3/MIXTRACK PRO 3/ MIXTRACK PLATINUM

FRMIXTRACK3BL

- Black Label™
- Low Profile
- fits Numark Mixtrack 3 / Pro 3 / Platinum
- 24.75" x 6.5" x 14.5" 13 lbs.



NUMARK MIXTRACK 3/MIXTRACK PRO 3/ MIXTRACK PLATINUM

FRGSMIXTRACK3

- Glide Style™
- Low Profile
- fits Numark Mixtrack 3 / Pro 3 / Platinum
- 26.5" x 7" x 15" 18 lbs.



NUMARK MIXTRACK 3/MIXTRACK PRO 3/ MIXTRACK PLATINUM

FRGSMIXTRACK3BL

- Glide Style™
- Black Label™
- Low Profile
- fits Numark Mixtrack 3 / Pro 3 / Platinum
- 26.5" x 7" x 15" 18 lbs.



NUMARK NS7III FZPIDDJRZW

- fits Pioneer DDJ-RZ/SZ/SZ2,
Numark NS7 / NS7 II / NS7 III
- 37.5" x 9" x 22" 33 lbs.



NUMARK NS7III FZPIDDJRZWB

- Black Label™
- fits Pioneer DDJ-RZ/SZ/SZ2,
Numark NS7 / NS7 II / NS7 III
- 37.5" x 9" x 22" 33 lbs.



NUMARK NS7III FZGSNS73WX1

- Glide Style™
- 1U 19" Rack Space
- fits NS7/ NS7 II / NS7 III
- 36.25"W x 11.5"H x 23.25"D 46 lbs.



NUMARK NS7III FZGSNS73WX1BL

- Black Label™
- Glide Style™
- 1U 19" Rack Space
- fits NS7/ NS7 II / NS7 III
- 36.25"W x 11.5"H x 23.25"D 46 lbs.



NUMARK NV / NVII

- FZNV**
- Low Profile
 - fits Numark NV/NVII
 - 24.75" x 6.5" x 18" 14 lbs.



NUMARK NV / NVII

- FZNVBL**
- Low Profile
 - Black Label™
 - fits Numark NV/NVII
 - 24.75" x 6.5" x 18" 14 lbs.



NUMARK NV / NVII

- FZGSNV**
- Glide Style™
 - Low Profile
 - fits Numark NV/NVII
 - 26" x 7.5" x 18.75" 20 lbs.



NUMARK NV / NVII

- FZGSNVBL**
- Glide Style™
 - Black Label™
 - Low Profile
 - fits Numark NV/NVII
 - 26" x 7.5" x 18.75" 20 lbs.



PIONEER DDJ-RB

- FRPIDDJRB**
- Low Profile
 - fits Pioneer DDJ-RB
 - 22.5" x 6.5" x 16.5" 13 lbs.



PIONEER DDJ-RB

- FRPIDDJRBBL**
- Black Label™
 - Low Profile
 - fits Pioneer DDJ-RB
 - 22.5" x 6.5" x 16.5" 13 lbs.



PIONEER DDJ-RB

- FRGSPIDDJRB**
- Glide Style™
 - Low Profile
 - fits Pioneer DDJ-RB
 - 23.75" x 7" x 16.5" 17 lbs.



PIONEER DDJ-RB

- FRGSPIDDJRBBL**
- Black Label™
 - Glide Style™
 - Low Profile
 - fits Pioneer DDJ-RB
 - 23.75" x 7" x 16.5" 17 lbs.



PIONEER DDJ-RR/SR CONTROLLER CASES

PIONEER DDJ-RR/SR FRPIDDJRRBL

- Black Label™
- Low Profile
- fits Pioneer DDJ-RR/SR
- 25.25" x 6.5" x 18.5" 15 lbs.



PIONEER DDJ-RR/SR FRPIDDJRR

- Low Profile
- fits Pioneer DDJ-RR/SR
- 25.25" x 6.5" x 18.5" 15 lbs.



PIONEER DDJ-RR/SR FRGSPIDDJRR

- Glide Style™
- Low Profile
- fits Pioneer DDJ-RR/SR
- 26.5" x 7" x 18.5" 20 lbs.



PIONEER DDJ-RR/SR FRGSPIDDJRRBL

- Black Label™
- Glide Style™
- Low Profile
- fits Pioneer DDJ-RR/SR
- 26.5" x 7" x 18.5" 20 lbs.



PIONEER DDJ-RX/SX2 CONTROLLER CASES

NEW

PIONEER DDJ-RX / DDJ-SX / DDJ-SX2 FRPIDDJRX

- fits Pioneer DDJ-RX/SX/SX2
- 30.75" x 9.5" x 19" 27 lbs.



PIONEER DDJ-RX/SX2

- FZPIDDJSXBL**
- Black Label™
 - fits Pioneer DDJ-RX/SX/SX2/S1/T1
 - 31.25" x 8.75" x 18.75" 24 lbs.

PIONEER DDJ-RX/SX2

- FZPIDDJSX**
- fits Pioneer DDJ-RX/SX/SX2/S1/T1
 - 31.25" x 8.75" x 18.75" 24 lbs.

PIONEER DDJ-RX/SX2 CONTROLLER CASES



PIONEER DDJ-RX/SX2
FZGSPIDDJSXBL

- 1U rack space
- Black Label™
- Glide Style™
- fits Pioneer DDJ-RX/SX/SX2/S1/T1
- 32" x 8.75" x 18.75" 34 lbs.



PIONEER DDJ-RX/SX2
FZGSPIDDJSX

- Glide Style™
- fits Pioneer DDJ-RX/SX/SX2/S1/T1
- 32" x 8.75" x 18.75" 34 lbs.



PIONEER DDJ-RX/SX2
FZGSPIDDJSX2

- Glide Style™
- 1U rack space
- fits Pioneer DDJ-RX/SX/SX2
- 31" x 9.5" x 18.5" 29 lbs.



PIONEER DDJ-RX/SX2
FZGSPIDDJSX2BL

- Black Label™
- Glide Style™
- 1U rack space
- fits Pioneer DDJ-RX/SX/SX2
- 31" x 9.5" x 18.5" 29 lbs.

PIONEER DDJ-RZ/SZ2 CONTROLLER CASES

NEW

PIONEER DDJ-RZ / SZ2
FRGSPIDDJRZW

- Glide Style™
- fits Pioneer DDJ-RZ/SZ/SZ2
- 38.25" x 9.5" x 22.75" 45 lbs.



NEW

PIONEER DDJ-RZ / SZ2
FRPIDDJRZW

- fits fits Pioneer DDJ-RZ/SZ/SZ2,
Numark NS7/NS7II/NS7III
- 37.75" x 9.5" x 22" 36 lbs.



PRODUCT GUIDE

PIONEER DDJ-RZ/SZ2 CONTROLLER CASES

PIONEER DDJ-RZ/SZ2 FZGSPIDDJSZWR

- Glide Style™
- three 1U rack spaces
- fits Pioneer DDJ-RZ/SZ/SZ2
- 43" x 22.25" x 12.25" 55 lbs.



PIONEER DDJ-RZ/SZ2 FZPIDDJRZW

- fits Pioneer fits Pioneer DDJ-RZ/SZ/SZ2, Numark NS7 / NS7 II / NS7 III
- 37.5" x 9" x 22" 33 lbs.



PIONEER DDJ-RZ/SZ2 FZPIDDJRZWBL

- Black Label™
- fits Pioneer fits Pioneer DDJ-RZ/SZ/SZ2, Numark NS7 / NS7 II / NS7 III
- 37.5" x 9" x 22" 33 lbs.

PIONEER DDJ-RZ/SZ2, DDJ-RZX CONTROLLER CASES

PIONEER DDJ-RZ/SZ2 FZGSPIDDJSZGT

- Glide Style™
- Glide Tray
- fits Pioneer DDJ-RZ/SZ/SZ2
- 38.75" x 10" x 22" 49 lbs.



PIONEER DDJ-RZ/SZ2 FZGSPIDDJSZGTBL

- Glide Style™
- Glide Tray
- Black Label™
- fits Pioneer DDJ-RZ/SZ/SZ2
- 38.75" x 10" x 22" 49 lbs.



NEW PIONEER DDJ-RZX FZPIDDJRZXWBL

- Black Label™
- Low Profile
- fits Pioneer DDJ-RZX
- 41.25" x 8.75" x 28" 39 lbs.



NEW PIONEER DDJ-RZX FZPIDDJRZXW

- Low Profile
- fits Pioneer DDJ-RZX
- 41.25" x 8.75" x 28" 39 lbs.



PIONEER DDJ-SB2 CONTROLLER CASES

PIONEER DDJ-SB2

FRPIDDJSB

- fits Pioneer DDJ-SB/SB2, Numark Mixtrack II / Pro II
- 24.25" x 7" x 15.25" 14 lbs.



PIONEER DDJ-SB2

FRPIDDJSBBL

- Black Label™
- fits Pioneer DDJ-SB/SB2, Numark Mixtrack II / Pro II
- 24.25" x 7" x 15.25" 14 lbs.



PIONEER DDJ-SB2

FRGSPIDDJSBBL

- Glide Style™
- Black Label™
- Fit Pioneer DDJ-SB/SB2, Numark Mixtrack II / Pro II
- 25.5" x 8" x 15.25" 19 lbs.



PIONEER DDJ-SB2

FRGSPIDDJSB

- Glide Style™
- Fit Pioneer DDJ-SB/SB2, Numark Mixtrack II / Pro II
- 25.5" x 8" x 15.25" 19 lbs.



PIONEER DDJ-SR CONTROLLER CASES

(see also Pioneer DDJ-RR/SR section pg. 25)

PIONEER DDJ-SR

CPIDDJSR

- Carpeted
- fits Pioneer DDJ-SR
- 25" x 6.5" x 17.5" 15 lbs.



PIONEER DDJ-SR

FRPIDDJSR

- fits Pioneer DDJ-SR
- 25.25" x 8.75" x 17.5" 18 lbs.



PIONEER DDJ-SR

FRPIDDJSRBL

- Black Label™
- fits Pioneer DDJ-SR
- 25.25" x 8.75" x 17.5" 18 lbs.



(see also Pioneer DDJ-RR/SR section pg. 25)



**PIONEER DDJ-SR
FZGSPIDDJSR**

- Glide Style™
- fits Pioneer DDJ-SR
- 27" x 8.75" x 17.5" 24 lbs.



**PIONEER DDJ-SR
FZGSPIDDJSRBL**

- Glide Style™
- Black Label™
- fits Pioneer DDJ-SR
- 27" x 8.75" x 17.5" 24 lbs.

**PIONEER DDJ-WEGO4
FRWEGO**

- fits Pioneer DDJ-WEGO/WEGO2/
WEGO3/WEGO4 and similar size gear
10" to 15"W x 10.25"D, up to 3" H
- 17" x 6.75" x 12.25" 8 lbs.



**PIONEER DDJ-WEGO4
FRWGOBL**

- Black Label™
- fits Pioneer DDJ-WEGO/WEGO2/
WEGO3/WEGO4 and similar size gear
10" to 15"W x 10.25"D, up to 3" H
- 17" x 6.75" x 12.25" 8 lbs.



**PIONEER XDJ-R1
FZPIXDJR1**

- fits Pioneer XDJ-R1
- 28.75" x 9.25" x 18.5" 25 lbs.



**PIONEER XDJ-R1
FZPIXDJR1BL**

- Black Label™
- fits Pioneer XDJ-R1
- 28.75" x 9.25" x 18.5" 25 lbs.



PIONEER XDJ-R1 CONTROLLER CASES

PIONEER XDJ-R1

FZGSP1XDJR1

- Glide Style™
- fits Pioneer XDJ-R1
- 30.75" x 10" x 20.5" 36 lbs.



PIONEER XDJ-R1

FZGSP1XDJR1BL

- Glide Style™
- Black Label™
- fits Pioneer XDJ-R1
- 30.75" x 10" x 20.5" 36 lbs.



PIONEER XDJ-R1

FZGSP1XDJR1GT

- Glide Style™
- Glide Tray™
- fits Pioneer XDJ-R1
- 30.5" x 11.5" x 18.75" 39 lbs.



PIONEER XDJ-R1

FZGSP1XDJR1GTBL

- Glide Style™
- Glide Tray™
- Black Label™
- fits Pioneer XDJ-R1
- 30.5" x 11.5" x 18.75" 39 lbs.



PIONEER XDJ-RX

FZPIXDJRX

- Low Profile
- fits Pioneer XDJ-RX
- 31.75" x 7.5" x 20.75" 22 lbs.



PIONEER XDJ-RX

FZPIXDJRXBL

- Black Label™
- Low Profile
- fits Pioneer XDJ-RX
- 31.75" x 7.5" x 20.75" 22 lbs.



PIONEER XDJ-RX

FZGSXDJRXGTW

- Glide Style™
- Glide Tray™
- fits Pioneer XDJ-RX
- 33.25" x 11.25" x 21.75" 44 lbs.



PIONEER XDJ-RX

FZGSXDJRXGTWBL

- Glide Style™
- Glide Tray™
- Black Label™
- fits Pioneer XDJ-RX
- 33.25" x 11.25" x 21.75" 44 lbs.



RELOOP TERMINAL MIX 8 / ROLAND DJ-808 CONTROLLER CASES

RELOOP TERMINAL MIX 8

FZTERMIX8

- fits Reloop Terminal Mix 8
- 23.5" x 8.5" x 19.75" 21 lbs.



RELOOP TERMINAL MIX 8

FZTERMIX8BL

- Black Label™
- fits Reloop Terminal Mix 8
- 23.5" x 8.5" x 19.75" 21 lbs.



ROLAND DJ-808 CONTROLLER CASES



ROLAND DJ-808 **NEW**

FZGSDJ808W2

- Glide Style™
- 2u rack space
- fits Denon MC7000, Pioneer DDJ-RX/SX/SX2, Roland DJ-808
- 32" x 11.5" x 22" 42 lbs.



ROLAND DJ-808 **NEW**

FZGSDJ808W2BL

- Black Label™
- Glide Style™
- 2u rack space
- fits Denon MC7000, Pioneer DDJ-RX/SX/SX2, Roland DJ-808
- 32" x 11.5" x 22" 42 lbs.

ROLAND DJ-808 **NEW**

FRRODJ808XD

- Fits Roland DJ-808
- 30.5" x 9.75" x 18.75" 28 lbs.



ROLAND DJ-808 **NEW**

FRGSDJ808XD

- Glide Style™
- Fits Roland DJ-808
- 30.5" x 9.5" x 22.75" 37 lbs.



ROLAND DJ-808 **NEW**

FZDJ808

- fits Denon MC7000, Pioneer DDJ-RX/SX/SX2, Roland DJ-808
- 29.5" x 7.75" x 21.5" 22 lbs.



ROLAND DJ-808 **NEW**

FZDJ808BL

- Black Label™
- fits Denon MC7000, Pioneer DDJ-RX/SX/SX2, Roland DJ-808
- 29.5" x 7.75" x 21.5" 22 lbs.

COMPLETE CONTROL CONTROLLER CASES

COMPLETE CONTROL S

FRDJCS

- fits Small to Medium size DJ controllers
- 23.75"x 9.5"x 18.5" 24 lbs.

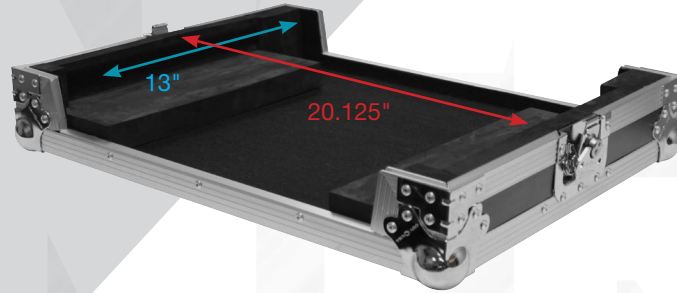

COMPLETE CONTROL M

FRDJCM

- fits Medium to Large size DJ controllers
- 27.75"x 9.5"x 18.75" 26 lbs.



COMPLETE CONTROL

FRDJCL

- fits Large size DJ controllers
- 30.5"x 9.75"x 18.75" 28 lbs.

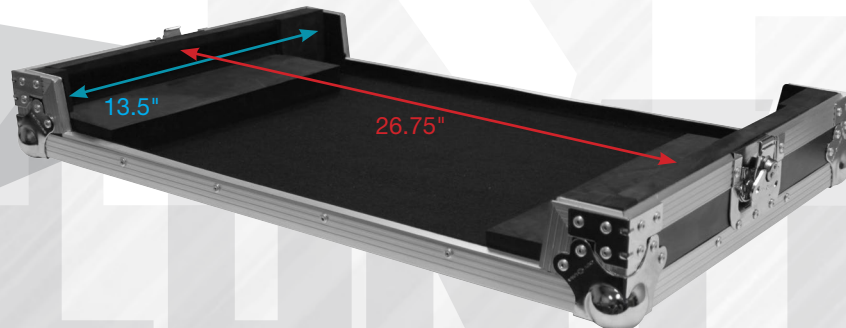

COMPLETE CONTROL CONTROLLER CASES

COMPLETE CONTROL S

FRGSDJCS

- Glide Style™
- fits Small to Medium Size Controllers
- 25"x 9.75"x 18.75" 29 lbs.

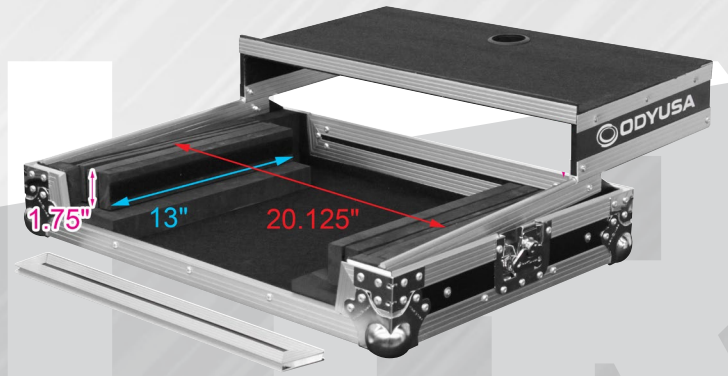

COMPLETE CONTROL M

FRGSDJCM

- Glide Style™
- fits Medium to Large Size Controllers
- 28.75"x 9.75"x 19" 32 lbs.

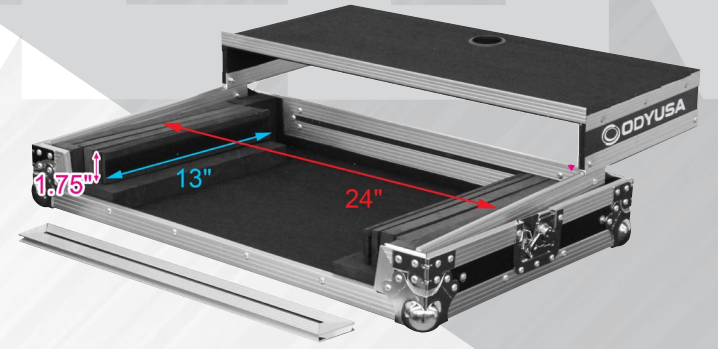

COMPLETE CONTROL L

FRGSDJCL

- Glide Style™
- fits Large Size Controllers
- 31.75"x 9.75"x 19" 35 lbs.

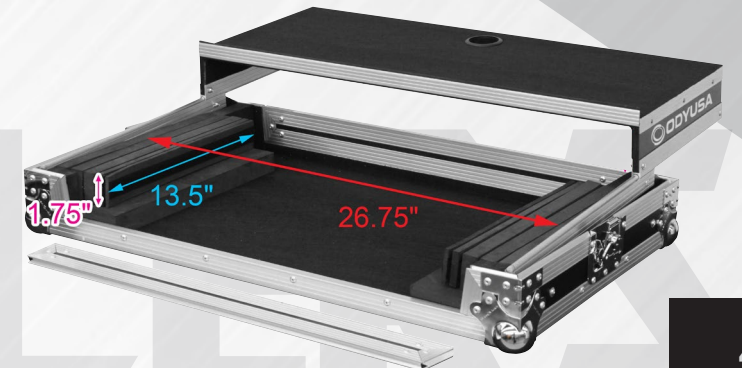

COMPLETE CONTROL CONTROLLER CASES

COMPLETE CONTROL 1

FZGSDJC1

- Glide Style™ Pro Series
- fits Medium Size Controllers
- 24.75" x 8.75" x 18.25" 25 lbs.

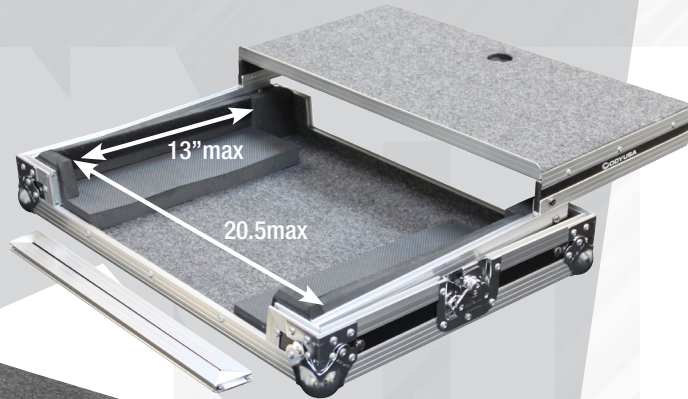

COMPLETE CONTROL 1L

FZGSDJC1L

- Glide Style™ Pro Series
- fits Larger Medium Size Controllers
- 28.75" x 8.75" x 18.75" 29 lbs.

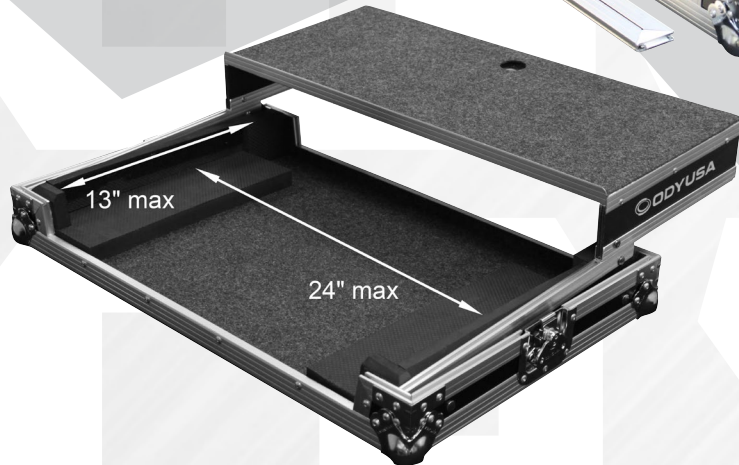

COMPLETE CONTROL 2

FZGSDJC2

- Glide Style™ Pro Series
- fits Large Size Controllers
- 31.5" x 8.75" x 18.75" 31 lbs.

BLACK KROM™ SERIES CONTROLLER CASES

DJ CONTROLLER CASE 1

KDJC1BL

- Black Krom™
- fits Extra Small DJ Controllers
- Slanted Tray fits gear up to 15.75"W x 13.5"D x 3.5"H
- 18.25" x 7.25" x 17.5" 12 lbs.



DJ CONTROLLER CASE 2

KDJC2BL

- Black Krom™
- fits Small DJ Controllers
- Slanted Tray fits gear up to 19.75"W x 13.5"D x 4"H
- 21.5" x 7.75" x 18.5" 13 lbs.

DJ CONTROLLER CASE 3

KDJC3BL

- Black Krom™
- fits Medium DJ Controllers
- Slanted Tray fits gear up to 23.75"W x 13.5"D x 3"H
- 25.5" x 7.75" x 18.25" 15 lbs.





UTILITY DJ CONTROLLER CARRY BAG
BRLNVC

- Fully Padded Strong Durable Polycarbonate Frame
- Customizable Adjustable Foam Inserts
- Dedicated Laptop Compartment
- Cable Holders and Pull-up Handle Sling
- Interior: 21.5" x 3.5" x 14.25"
- Exterior: 23" x 15" x 8" 8 lbs.



DJ MEDIA/MIXER BAG
BRLDIGITAL

- Fully Padded, Strong Durable Polycarbonate Frame
- Customizable Adjustable Foam Inserts
- Dedicated Laptop Compartment
- Cable Holders and Pull-up Handle Sling
- Interior: 17.5" x 13" x 3.5"
- Exterior: 19" x 15.5" x 8" 6 lbs.



XLE DJ MEDIA CONTROLLER BAG
BRLDIGITALXLE

- Fully Padded Strong Durable Polycarbonate Frame
- Customizable Adjustable Foam Inserts
- Dedicated Laptop Compartment
- Cable Holders and Pull-up Handle Sling
- Interior: 21.5" x 3.5" x 14.25"
- Exterior: 23" x 15" x 8" 8 lbs.

NO SMALL BAG INCLUDED

XL DJ MEDIA CONTROLLER BAG
BRLDIGITALXL

- Fully Padded for Gear Protection
- Heavy-Duty Zippers and Zipper Pulls
- Convenient Elastic Band Cable Holders
- Main Compartment Internal Dimensions: 23.25" x 16.5" x 2.5"
- Front Compartments Internal Dimensions: 16" x 9.75" x 1.5"

Additional gear bag included



2XL DJ MEDIA CONTROLLER BAG
BRLDIGITAL2XL

- Fully Padded, Strong Durable Polycarbonate Frame
- Customizable Adjustable Foam Inserts
- Cable Holders and Dual Handle Strap
- Additional Removable Shoulder Strap
- Exterior: 28" x 14" x 5.5" 4 lbs.



3XL DJ MEDIA CONTROLLER BAG
BRLDIGITAL3XL

- Fully Padded Pockets and Pouches
- Adjustable Foam Inserts
- Cable Holders and Dual Handle Straps
- Additional Removable Shoulder Strap
- Exterior: 36" x 19" x 9" 6 lbs.



REDLINE™ SERIES



DIGITAL GEAR DJ BACKPACK BRLBACKSPIN2

- Fully Padded for Gear Protection
- Padded Interior Dividers for Organized Packing
- Dedicated Adjustable Compartment for Laptop
- Dedicated Headphone Compartment
- Dedicated LSTANDM/LSTAND360 Laptop Stand Compartment
- Convenient Elastic Band Cable Holders
- Padded Back, Handle, and Shoulder Straps for Extra Comfort
- 19" x 20" x 13" 6 lbs.

DIGITAL GEAR REMIX BACKPACK BRLRMXBP1

- Fully Padded for Gear Protection
- Dedicated Compartment for Laptop
- Dedicated Headphone Compartment
- Dedicated LSTANDM/LSTAND360 Laptop Stand Compartment
- Dedicated iPad/Digital Tablet Compartment
- Heavy-Duty Zippers and Zipper Pulls
- Convenient Elastic Band Cable Holders
- Padded Back, and Back Pack Straps
- 16" x 19" x 10" 4 lbs.



REMIXMK2™ SERIES

A NEW STANDARD IN MOBILE REMIXING

TOURING TROLLEY GEAR BAG BRXMK2CTRLW

ON-THE-GO COMPACT BACKPACK BRXMK2BP10

GIG TO GIG LARGE SIZE BACKPACK BRXMK2BP12



REMIXMK2™
SERIES
A NEW STANDARD IN MOBILE REMIXING

**DIGITAL GEAR
BACKPACKS**

- Fully Padded for Gear Protection
- Dedicated Compartment for Laptop
- Dedicated Interior Headphone Pouch
- Dedicated Digital Tablet Compartment
- Heavy-Duty Zippers and Zipper Pulls
- Multiple Interior Compartments and Padded Pockets
- Padded Back, Handle, and Shoulder Straps for Extra Comfort



**BRXMK2BP10
STANDARD SIZE**

- Inconspicuous 9" x 5" Exterior Stash Pocket
- Main Interior Compartment When Pockets are Empty is Approximately 16" x 10.5" x 3"
- Ext Dim: 13" x 19" x 7" 2 lbs.



Also great for PORTABLIST gear



**BRXMK2BP12
LARGE SIZE**

- Inconspicuous 9" x 5" Exterior Stash Pocket
- Main Interior Compartment When Pockets are Empty is Approximately 16" x 10.5" x 3"
- Ext Dim: 16.5" x 21" x 9.5" 3 lbs.

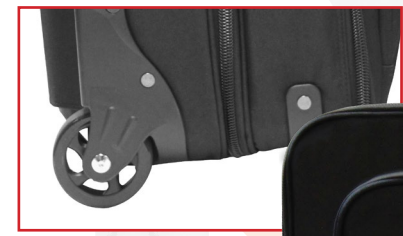

REMIXMK2™
SERIES
A NEW STANDARD IN MOBILE REMIXING

**CONTROL
DIGITAL DJ
TROLLEY**

BRXMK2CTRLW

- Multiple Padded Pockets and Pouches for Gear Protection
- Dedicated Interior Headphone Pouch
- Dedicated Compartment for Laptop
- Dedicated Digital Tablet Compartment
- Reinforced Protective Frame
- Heavy-Duty Zippers and Zipper Pulls
- Strong Telescoping Handle Extends 17"
- 20" x 11.5" Front Exterior Compartment
- Main Compartment When Pockets are Empty is 22" x 14.5" x 4"
- Secondary Compartment When Pockets are Empty is 22" x 14.5" x 3"
- Includes 6 Foam Padded Strips to Secure Gear for Protected Transport
- Custom Smooth 3" Diameter Wheels
- Ext Dim: 15.5" x 26.5" - 41.25" x 11" 9 lbs.

**FLOW TO YOUR
NEXT GIG
WITH THESE
NEW COMPACT CONTOUR
CONTROLLER
BAGS**

STREAMLINE™

THE NEW STANDARD IN DJ GEAR PROTECTION

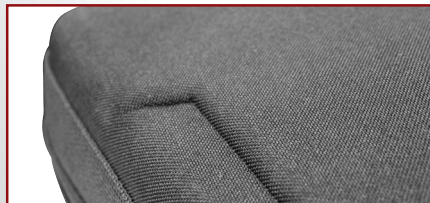

The perfect bags for mobile dj's on the go. Features embossed corners and a 2" thick eggshell foam padded interior to protect your controller and other essentials from vibrations and shock.



The extra spacious dual foam interior is great for your essential compact accessories such as laptops, tablets, power supplies, hard drives, cables, folding laptop stands, microphones and more. *



Custom interior foam is available as shown in the photo above.

*For the safety of your equipment, proper protective cases/pouches for each individual gear (laptops, tablets, folding laptop/gear stands, power sources and cables, etc. are required when transporting them together within the same compartment. Stay within the molded bag's capacity to ensure the best protection for your gear.

STREAMLINE™
THE NEW STANDARD IN DJ GEAR PROTECTION

**UNIVERSAL DJ CONTROLLER/ UTILITY
EVA MOLDED CARRYING BAGS**

- Features and Specifications
- Sleek Reinforced Stitched Eva Molded Shell Design
 - Embossed Corner
 - Dual Convoluted Foamed-lined Padded Interior
 - Optional Foam Sheets Available for Interior Customization
 - Durable Yet Lightweight
 - Large Top Grade Custom Logo Zippers
 - Comfortable Rivet Enforced Double Handles
 - Non-slip Shoulder Straps



SIZE EXTRA LARGE
BMSLDJXL



SIZE EXTRA LARGE
BMSLDJCL



SIZE EXTRA LARGE
BMSLDJCM



SIZE EXTRA LARGE
BMSLDJCS



BMSLROD808

ROLAND
DJ-808 SERATO
DJ CONTROLLER
CARRYING BAG



BMSLDNMC7000

DENON MC7000
DJ CONTROLLER
CARRYING BAG

SKU	EXT. DIMENSIONS	INT. DIMENSIONS	WEIGHT
BMSLDJXL	36.25" x 18" x 5"	36" x 17.75" x 4.75	5 lbs
BMSLDJCL	30.25" x 18" x 5"	30" x 18" x 4.75	5 lbs
BMSLDJCM	26.75" x 16.5" x 5"	26" x 16.25" x 4.75	4 lbs
BMSLDJCS	22.50" x 14.5" x 5"	22.25" x 14.25" x 4.75	4 lbs
BMSLROD808	30.25" x 18.25" x 5"	31" x 19" x 5	5 lbs
BMSLDNMC7000	30.25" x 18.25" x 5"	31" x 19" x 5	5 lbs

INVENTORS OF THE EXTRAORDINARY

Flight FX™ Series cases have one to two color-changing multi-mode LED panels embedded into their lower exterior side walls. In addition, they are constructed with the same anodized and powder coated black hardware as our Flight Zone® Black Label™ cases which complement the visual aura of the glowing panel(s). Each Flight FX™ Series case can be synchronized to another and linked up for dazzling multiple case setups. The DJ becomes the center stage at any gig behind these cases. Innovating? Of Course!



CD/DIGITAL DJ COFFINS LARGE FORMAT

*China Patented. U.S. and Other Foreign Patents Pending



FFX10CDJWBL



FFX12CDJWBL

Large format CD/Digital DJ Coffins

fit players such as:

Denon SC5000 PRIME

Gemini CDJ-700, MDJ-1000

Pioneer CDJ-850/900NXS/2000NXS2, XDJ-1000MK2

Reeloc RMP-4



Recessed Rollers for easy transportation



*width adjustment foam included



- Front 7 Color-Changing LED Panel with Controller(linkable to other FX cases)
- LED panel Effects:
 - (1) Set to 1 Color or Random Color Changing,
 - (2) Slow Flashing Color Changing,
 - (3) Fast Flashing Color Changing,
 - (4) Auto Color Mixing Fade in Fade out,
 - (5) Sound Activated

MODEL	DIMENSIONS	WEIGHT	FITS
FFX10CDJWBL	42" x 9" x 21.63"	42 lbs.	10" Mixer, (2) large format CD/Digital Media Players
FFX12CDJWBL	43.75" x 9" x 21.63"	46 lbs.	12" Mixer, (2) large format CD/Digital Media Players



TURNTABLE DJ COFFINS

*China Patented. U.S. and Other Foreign Patents Pending



- Front 7 Color-Changing LED Panel with Controller(linkable to other FX cases)
- LED panel Effects:
 - (1) Set to 1 Color or Random Color Changing,
 - (2) Slow Flashing Color Changing,
 - (3) Fast Flashing Color Changing,
 - (4) Auto Color Mixing Fade in Fade out,
 - (5) Sound Activated



FFXBM10WBL



Recessed Rollers for easy transportation

FFXBM12WBL



MODEL	DIMENSIONS	WEIGHT	FITS
FFXBM10WBL	46" x 9" x 24.5"	46 lbs.	10" format mixer, two turntables in battle mode
FFXBM12WBL	49" x 9" x 24.5"	49 lbs.	12" format mixer, two turntables in battle mode

*Our turntable coffins can hold Numark, Pioneer, Stanton, as well as Technics 1200 style turntables!

CD/DIGITAL MEDIA DJ COFFINS - FLIGHT FX™

CD/MEDIA PLAYER CASES - FLIGHT FX™



LARGE FORMAT GLIDE STYLE™ CD/DIGITAL MEDIA DJ COFFIN

*China Patented. U.S. and Other Foreign Patents Pending

FFXGSL12CDJWRBL



- Front 7 Color-Changing LED Panel with Controller (linkable to other FX cases)
- LED panel Effects:
 - (1) Set to 1 Color or Random Color Changing,
 - (2) Slow Flashing Color Changing,
 - (3) Fast Flashing Color Changing,
 - (4) Auto Color Mixing Fade in Fade out,
 - (5) Sound Activated

Large format CD/Digital DJ Coffins fit players such as:
 Denon SC5000 PRIME
 Gemini CDJ-700, MDJ-1000
 Pioneer CDJ-850/900NXS/2000NXS2, XDJ-1000MK2
 Reloop RMP-4

*width adjustment foam included

Wheels for easy transportation



MODEL	DIMENSIONS	WEIGHT	FITS
FFXGSL12CDJWRBL	44.5" x 8.75" x 20.5"	43 lbs.	12" Format Mixer, (2) large format CD/Digital Media player

*This case is not designed to transport laptops.



GLIDE STYLE™ TURNTABLE DJ COFFINS

*China Patented. U.S. and Other Foreign Patents Pending



- Front 7 Color-Changing LED Panel with Controller (linkable to other FX cases)
- LED panel Effects:
 - (1) Set to 1 Color or Random Color Changing,
 - (2) Slow Flashing Color Changing,
 - (3) Fast Flashing Color Changing,
 - (4) Auto Color Mixing Fade in Fade out,
 - (5) Sound Activated

FFXGSLBM10WBL

MODEL	DIMENSIONS	WEIGHT	FITS
FFXGSLBM10WBL	46" x 9" x 24.25"	50 lbs.	10" format mixer, (2) Turntable in Battle Mode
FFXGSLBM12WBL	48.25" x 9" x 24.25"	56 lbs.	12" format mixer, (2) Turntable in Battle Mode

*These cases are not designed to transport laptops.

**Our turntable coffins can hold Numark, Pioneer, Stanton, as well as Technics 1200 style turntables!



CD/DIGITAL MEDIA PLAYER CASES

*China Patented. U.S. and Other Foreign Patents Pending



- Front 7 Color-Changing LED Panel with Controller (linkable to other FX cases)
- LED panel Effects:
 - (1) Set to 1 Color or Random Color Changing,
 - (2) Slow Flashing Color Changing,
 - (3) Fast Flashing Color Changing,
 - (4) Auto Color Mixing Fade in Fade out,
 - (5) Sound Activated



FFXCDJBL

Large format CD/Digital DJ Coffins fit players such as:
 Denon SC5000 PRIME
 Gemini CDJ-700, MDJ-1000
 Pioneer CDJ-850/900NXS/2000NXS2, XDJ-1000MK2
 Reloop RMP-4



*width adjustment foam included



FFX2RCDJBL
Right side dual LED panel case



Shown with optional ATT2 truss table

MODEL	DIMENSIONS	WEIGHT	FITS
FFXCDJBL	21.5" x 8.5" x 15.25"	18 lbs.	large format CD/Digital Media Players
FFX2RCDJBL	21.5" x 8.5" x 15.25"	18 lbs.	large format CD/Digital Media Players right side dual LED panel case
FFX2LCDJBL	21.5" x 8.5" x 15.25"	18 lbs.	large format CD/Digital Media Players left side dual LED panel case



FFX2LCDJBL
Left side dual LED panel case

FLIGHT FX™ LED panel series

TURNTABLE CASES

*China Patented. U.S. and Other Foreign Patents Pending

FFXBM1200BL
Battle position

FFXDJ1200BL
Standard DJ position



- Front 7 Color-Changing LED Panel with Controller (linkable to other FX cases)
- LED panel Effects:
 - (1) Set to 1 Color or Random Color Changing,
 - (2) Slow Flashing Color Changing,
 - (3) Fast Flashing Color Changing,
 - (4) Auto Color Mixing Fade in Fade out,
 - (5) Sound Activated



Shown with ATT2 truss table

FFX2LBM1200BL
Left side battle position / Right side standard DJ position.

FLIGHT FX2™ 2 LED panel series



FFX2RBM1200BL
Right side battle position / Left side standard DJ position.

MODEL	DIMENSIONS	WEIGHT	FITS
FFXBM1200BL	17.75" x 9" x 21"	18 lbs.	Technics 1200 style turntable in battle position
FFXDJ1200BL	21" x 9" x 17.75"	18 lbs.	Technics 1200 style turntable in standard position
FFX2RBM1200BL	17.75" x 9" x 21"	18 lbs.	Technics 1200 style turntable in battle(right)/standard(left) position
FFX2LBM1200BL	17.75" x 9" x 21"	18 lbs.	Technics 1200 style turntable in battle(left)/standard(right) position

*Our turntable coffins can hold Numark, Pioneer, Stanton, as well as Technics 1200 style turntables!

FLIGHT FX™ LED panel series

DJ MIXER CASES

*China Patented. U.S. and Other Foreign Patents Pending

FFX10MIXBL



FFX12MIXBL



MODEL	DIMENSIONS	WEIGHT	FITS
FFX10MIXBL	13.75" x 9.5" x 22"	19 lbs.	most 10" format mixers
FFX12MIXBL	15.75" x 9.5" x 22"	20 lbs.	most 12" format mixers

FLIGHT FX2™ 2 LED panel series

GLIDE STYLE™ DJ MIXER CASES

*China Patented. U.S. and Other Foreign Patents Pending



- Front 7 Color-Changing LED Panel with Controller (linkable to other FX cases)
- LED panel Effects:
 - (1) Set to 1 Color or Random Color Changing,
 - (2) Slow Flashing Color Changing,
 - (3) Fast Flashing Color Changing,
 - (4) Auto Color Mixing Fade in Fade out,
 - (5) Sound Activated

FFXGS10MX1BL



FFXGS10BL



MODEL	DIMENSIONS	WEIGHT	FITS
FFXGS10BL	22" x 12.5" x 20.5"	33 lbs.	most 19" rack mount mixers (10u Rack)
FFXGS10MX1BL	15" x 8.25" x 21"	21 lbs.	most 10" format mixers
FFXGS12MX1BL	17" x 8.25" x 20.75"	23 lbs.	most 12" format mixers

*These cases are not designed to transport laptops.

FLIGHT FX™ LED PANEL ACCESSORIES

MODEL	DISCRIPTION
ACAT503	3 ft. blk CAT5E cable
ACAT506	6 ft. blk CAT5E cable

ADIN403MF



ACAT503/506



MODEL	DISCRIPTION
ADIN403MF	3 ft. M/F 4 Pin Din Cable Extension
AFFXLEDC-S2	Control Box w/Power adaptor



CD/DIGITAL MEDIA DJ COFFINS LARGE FORMAT



FZ12CDJWBL



NEW

Large format CD/Digital DJ Coffins fit players such as:
Denon SC5000 PRIME
Gemini CDJ-700, MDJ-1000
Pioneer CDJ-850/900NXS/2000NXS2, XDJ-1000MK2
Reloop RMP-4



Recessed Rollers for easy transportation



*width adjustment foam included

FZ12CDJWDBL made Extra Deep for larger players & 12" format DJ mixers

Flight Zone Series:

MODEL	DIMENSIONS	WEIGHT	FITS
FZ10CDJWBL	41" x 9.5" x 20"	39 lbs.	10" format mixer, (2) large format CD/Digital Media Players
FZ12CDJWBL	43" x 9.5" x 19"	40 lbs.	12" format mixer, (2) large format CD/Digital Media Players
FZPi22000WBL	47.5" x 9.25" x 21"	50 lbs.	Pioneer DJM-2000 Mixer, (2) large format CD/Digital Media Players
FZ12CDJWDBL	45 x 9 x 21.25	42 lbs.	Extra Deep 12" format mixer, (2) large format CD/Digital Media Players



CD/DIGITAL MEDIA DJ COFFIN MEDIUM FORMAT

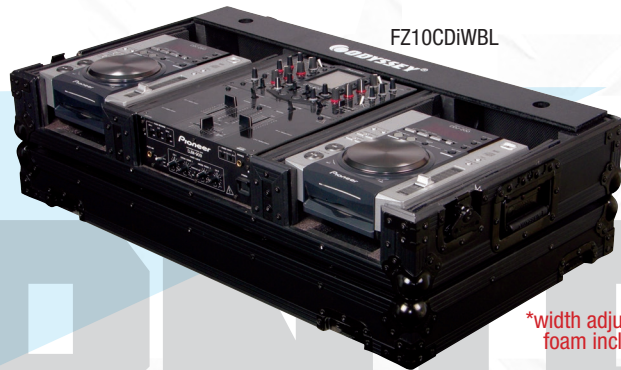

FZ10CDiWBL

Medium format CD/Digital DJ coffins fit players such as:
Gemini CDJ-300/650
Numark NDX200/500
Pioneer CDJ-350/XDJ-700
Stanton CMP.800

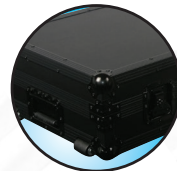

Recessed Rollers for easy transportation



*width adjustment foam included

Flight Zone Series:

MODEL	DIMENSIONS	WEIGHT	FITS
FZ10CDiWBL	34" x 9" x 20"	36 lbs.	10" format mixer, (2) medium format CD/Digital Media Players



PIONEER CD/ DIGITAL MEDIA DJ COFFINS



FZPi22000WBL



Recessed Rollers for easy transportation



*width adjustment foam included

Flight Zone Series:

MODEL	DIMENSIONS	WEIGHT	FITS
FZPi22000WBL	47.5" x 9.25" x 21"	50 lbs.	Pioneer DJM-2000 DJ Mixer & 2 Large Format CD/Digital Media Players
FZGS22000WBL*	47.25" x 12.75" x 21.25"	59 lbs.	Pioneer DJM-2000 DJ Mixer & 2 Large Format CD/Digital Media Players *(two tier glide platform)



TURNTABLE BATTLE STYLE DJ COFFINS



FZBM10WBL



Recessed Rollers for easy transportation

Flight Zone Series:

MODEL	DIMENSIONS	WEIGHT	FITS
FZBM10WBL	47" x 9" x 22.5"	53 lbs.	10" format mixer, (2) 1200 style turntables in Battle position
FZBM12WBL	49" x 9" x 22.5"	56 lbs.	12" format mixer, (2) 1200 style turntables in Battle position

*Our turntable coffins can hold Numark, Pioneer, Stanton, as well as Technics 1200 style turntables!



FZGSLBM12WRBL

GLIDE STYLE™ TURNTABLE DJ COFFINS

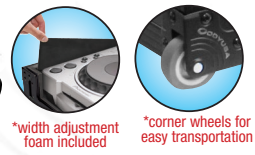

*width adjustment foam included
*corner wheels for easy transportation

Flight Zone Series:

MODEL	DIMENSIONS	WEIGHT	FITS
FZGSLBM10WRBL	46" x 9" x 23.5"	45 lbs.	10" format mixer, (2) 1200 Style Turntables in Battle Position
FZGSLBM12WRBL	48" x 9" x 23.75"	47 lbs.	12" format mixer, (2) 1200 Style Turntables in Battle Position

*Our turntable coffins can hold Numark, Pioneer, Stanton, as well as Technics 1200 style turntables! **These cases are not designed to transport laptops.

GLIDE STYLE™ CD/DIGITAL MEDIA DJ COFFINS



FZGS12CDJWBL
Dual tier glide platform

Large format CD/Digital DJ Coffins fit players such as:
Denon SC5000 PRIME
Gemini CDJ-700, MDJ-1000
Pioneer CDJ-850/900NXS/2000NXS2, XDJ-1000MK2
Reloop RMP-4



FZGSL12CDJWBL
Single tier glide platform

Flight Zone Series:

MODEL	DIMENSIONS	WEIGHT	FITS
FZGS12CDJWBL	42.75" x 12.25" x 19.5"	51 lbs.	12" format mixer, (2) large format CD/Digital media players
FZGSL12CDJWBL	44.5" x 8.75" x 20.5"	43 lbs.	12" format mixer, (2) large format CD/Digital media players

*These cases are not designed to transport laptops.

GSX GLIDE STYLE™ CD/DIGITAL MEDIA DJ COFFIN



Large format CD/Digital DJ Coffins fit players such as:
Denon SC5000 PRIME
Gemini CDJ-700, MDJ-1000
Pioneer CDJ-850/900NXS/2000NXS2, XDJ-1000MK2
Reloop RMP-4



FZGSX12CDJWBL



Odyssey's GSX Glide Style™ Series DJ coffins feature the ability to safely store your laptop inside the actual laptop platform that sits right above the mixer compartment. To access the compartment, the top section slides open left and right and includes key locks for security allowing the DJ to take a break from the booth without having to worry about theft. Just another innovative design to the Glide Style™ case family. A standard color Flight Zone® series case is also available.



Lockable laptop compartment

*width adjustment foam included

Recessed Rollers for easy transportation

Flight Zone Series:

MODEL	DIMENSIONS	WEIGHT	FITS
FZGSX12CDJWBL	42.75" x 12.25" x 19.5"	52 lbs.	12" format mixer, (2) large format CD/Digital Media players, includes lockable laptop compartment

*This case is not designed to transport laptops.



GLIDE STYLE™ CDJ COFFINS

As the evolution of the DJ continues, so do the designs of Odyssey DJ coffins. Introducing the BLACK LABEL™ REMIXER™ GLIDE STYLE™ SERIES DJ coffins featuring a full width glide platform to place all your DJ remix gear. With digital vinyl software such as Serato and Traktor Scratch more DJs have gone through the transition from beat mixing to full on remixer producer. Availability of so many affordable remixing tools to the DJ, such as midi keyboards and controllers to laptops and iPads, have grown to an ultimate high and Odyssey is there in the middle of it all providing these DJs the most functional DJ coffins yet with the REMIXER™ GLIDE STYLE™ SERIES. Standard color Flight Zone® cases are also available.

Large format CD/Digital DJ Coffins fit players such as:
 Denon SC5000 PRIME
 Gemini CDJ-700, MDJ-1000
 Pioneer CDJ-850/900NXS/2000NXS2, XDJ-1000MK2
 Reloop RMP-4



FZGSP12CDJWBL

Large format CD/Digital Media player DJ Coffin.



Recessed Rollers for easy transportation



*width adjustment foam included

FZGSPBM10WBL



Recessed Rollers for easy transportation



FZGSPBM12WBL

Flight Zone Series:

MODEL	DIMENSIONS	WEIGHT	FITS
FZGSP12CDJWBL	45" x 10.63" x 21"	52 lbs.	12" format mixer, (2) large format CD/Digital Media players
FZGSPBM10WBL	47.25" x 10.5" x 24.25"	56 lbs.	10" format mixer, (2) turntables in Battle Mode
FZGSPBM12WBL	49.5" x 10.5" x 24.5"	58 lbs.	12" format mixer, (2) turntables in Battle Mode

*These cases are not designed to transport laptops.

**Our turntable coffins can hold Numark, Pioneer, Stanton, as well as Technics 1200 style turntables!

Black Label Series
CD/DIGITAL MEDIA PLAYER CASE



FZCDJBL

Large format CD/Digital DJ Coffins fit players such as:
Denon SC5000 PRIME
Gemini CDJ-700, MDJ-1000
Pioneer CDJ-850/900NXS/2000NXS2, XDJ-1000MK2
Reloop RMP-4

Flight Zone Series:

MODEL	DIMENSIONS	WEIGHT	FITS
FZCDJBL	15.5" x 8.75" x 20.5"	18 lbs.	Large format CD/Digital Media Player

Black Label Series
TURNTABLE CASE



FZ1200BL

Flight Zone Series:

MODEL	DIMENSIONS	WEIGHT	FITS
FZ1200BL	21.5" x 9.5" x 21.5"	20 lbs.	1200 style turntables

*Our turntable cases can hold Pioneer, Numark, Stanton, as well as Technics 1200 style turntables!

Black Label Series
DJ MIXER CASES



FZ12MIXBL

FZDJM2000BL



FZ10MIXBL



FZ12MIXXDBL **NEW**



FZ10MIXXDBL **NEW**

Flight Zone Series:

MODEL	DIMENSIONS	WEIGHT	FITS
FZDJM2000BL	22" x 10" x 21"	20 lbs.	Pioneer DJM-2000
FZ10MIXBL	13" x 9.5" x 21.5"	18 lbs.	Most 10" format mixers
NEW FZ10MIXXDBL	14.25" x 8.25" x 21.75"	18 lbs.	Most 10" format mixers, extra deep rear cable space
FZ12MIXBL	15.5" x 9.5" x 19.5"	19 lbs.	Most 12" format mixers
NEW FZ12MIXXDBL	16.5" x 8.25" x 22.25"	19 lbs.	Most 12" format mixers, extra deep rear cable space

Black Label
Series

GLIDE STYLE™ DJ MIXER CASES

G Series
For Digital DJ's
**PATENTED
GLIDE STYLE**
(OTHER PATENTS PENDING)

FZGSDJM2000BL



FZGS10MX1BL



FZGS12RANE64BL
extra wide front access panel



These Black Label™ Patented Glide Style™ Mixer cases feature a sliding laptop platform mounted up above the mixer compartment. Incorporated into the FZGS10/12MX1BL case is an extra deep cable well area, plenty of room for power supplies as well as cables. Standard color Flight Zone® cases also available.

Flight Zone Series:

MODEL	Dimensions	WEIGHT	FITS
FZGSDJM2000BL	22" x 9" x 22"	26 lbs.	Pioneer DJM-2000 mixer
FZGS10MX1BL	15.5" x 8.5" x 20.25"	21 lbs.	10" format mixer
FZGS10BL	22.125" x 12.25" x 20"	32 lbs.	19" rack mount mixer (10u rack)
FZGS12MX1BL	17" x 8.25" x 20"	21 lbs.	12" format mixer
FZGS12RANE64BL	17" x 8.75" x 20"	21 lbs.	Rane 64/68/MP2015 mixer

*These cases are not designed to transport laptops.

Black Label
Series

FOLD-OUT STANDS



FZF3336BL



FZF2136BL



Our Black Label™ Flight Zone® fold-out table stands transform into a heavy-duty DJ stand in an instant. Use them for a home studio or have them set up on stage. These stands provide a clean, professional appearance that's easy to setup and teardown in addition to being easy-to-store and transport. Rugged hardware snaps all surfaces into place for added stability. Standard color Flight Zone® cases also available.

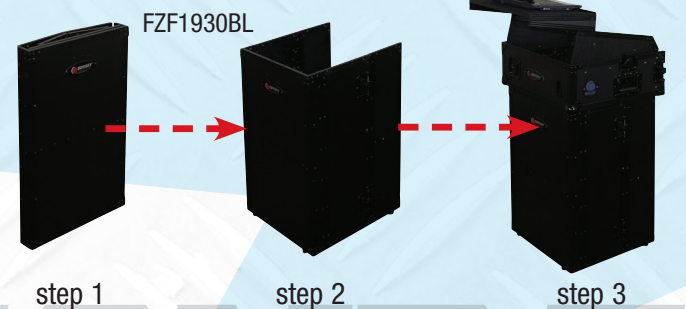

step 1

step 2

step 3

Flight Zone Series:

MODEL	DIMENSIONS (UNFOLDED)	WEIGHT	BEST USED FOR:
FZF1930BL	19" x 30" x 18.5"	26 lbs.	racks
FZF2136BL	21.5 x 36 x 17.75	28 lbs.	large DJ controller cases
FZF2636BL	26" x 36" x 18.5"	30 lbs.	coffins, consoles
FZF3336BL	33" x 36" x 18.5"	33 lbs.	coffins, consoles
FZF5437TBL	54" x 37" x 18.5"	45 lbs.	coffins, consoles, tabletop gear

Black Label Series AMP RACKS

FZAR16WBL



FZAR08BL



FZAR12WBL



FZADP



These sturdy Black Label™ ATA Amp Racks incorporate dual rack rails (front and rear), heavy-duty rubber feet (non-wheeled versions), spring-loaded handles, and removable front and rear covers. Designed to protect and transport larger amps and other standard 19" rack mountable gear. Standard color Flight Zone® series versions also available.

- Internal Depth (Rail to Rail): 16.5"
- Internal Depth (Rail to Cover): 19.75"

Flight Zone Series:

MODEL	DIMENSIONS	WEIGHT	SPACES
FZADP	20" x 5" x 23.5"	18 lbs.	(amp rack dolly plate)
FZAR04BL	21.5" x 10.5" x 25.25"	23 lbs.	4U
FZAR06BL	21.5" x 13.5" x 25.25"	28 lbs.	6U
FZAR08BL	21.5" x 16.5" x 25.25"	36 lbs.	8U
FZAR12WBL	21.5" x 26.5" x 25.25"	67 lbs.	12U (dolly plate included)
FZAR14W	21.5" x 28" x 25.25"	72 lbs.	14U (dolly plate included)
FZAR16WBL	21.5" x 29.5" x 25.25"	74 lbs.	16U (dolly plate included)

COMBO RACKS



FZ1116WDLXBL

- Internal Depth (Rail to Rail): 18.75"
- Internal Depth (Rail to Cover): 22.75"

Features side table

Our Black Label™ ATA Combo Racks give you the best of both worlds. Mount mixers and controllers on top for convenient access and all other essentials below. Each includes a top lid and front cover. The FZ1116WDLXBL version includes heavy-duty casters on a dolly plate (front casters feature sure stop brakes) and a cover that turns into a side mount tabletop that can be mounted on either side of the rack (table can hold approximately 200 lbs. evenly distributed). Standard color Flight Zone® cases are also available.



FZ1002BL

Flight Zone Series:

MODEL	DIMENSIONS	WEIGHT	SLANT	VERT.
FZ1002BL	21.5" x 15.25" x 24"	35 lbs.	10U	2U
FZ1004BL	21.5" x 18.5" x 24"	38 lbs.	10U	4U
FZ1006BL	21.5" x 23" x 24"	41 lbs.	10U	6U
FZ1116WDLXBL	21.5" x 44.25" x 26"	83 lbs.	11U	16U



GLIDE STYLE™ COMBO RACKS

FZGS1002BL



FZGS1006BL



FRGS808BL



These Black Label™ Flight Zone® Glide Style™ combo racks feature our patented sliding laptop platform mounted above a 19" slanted mixer rack section. Slide it forward to use your laptop. Slide it back to use the mixer section underneath. Also available in our standard color Flight Zone® series.

Flight Ready Series:

MODEL	DIMENSIONS	WEIGHT	SLANT	VERT
FRGS802BL	22" x 18.25" x 24"	33 lbs.	8U	4U
FRGS806BL	22" x 22" x 24"	36 lbs.	8U	6U
FRGS808BL	22" x 26" x 24"	38 lbs.	8U	6U

*These cases are not designed to transport laptops.

Flight Zone Series:

MODEL	DIMENSIONS	WEIGHT	SLANT	VERT
FZGS1002BL	22.25" x 16.25" x 24"	41 lbs.	10U	2U
FZGS1004BL	22.25" x 19.75" x 24"	44 lbs.	10U	4U
FZGS1006BL	22.25" x 23.75" x 24"	48 lbs.	10U	6U
FZGS1116WDLXBL	22.25" x 45.75" x 28.5"	103 lbs.	11U	16U

*These cases are not designed to transport laptops.



FZGS1116WDLXBL

- Interior Depth (rail to back door): 20"
- Table may be mounted on either side.
(weight capacity: 200 lbs. evenly distributed)



UTILITY CASES/ TRUCK PACKS



FZUTWBL

Features include:

- Foam-lined interior
- Hinged Lid
- Stacking Caster Plates
- Heavy-Duty Ball Corners
- Recessed Handles and Latches
- 4 Casters, 2 with brakes

Keep all your essential cables and gear safe and organized during transport with our Black Label™ truck pack cases. These cases feature a carpet-lined interior, recessed latches and handles, heavy-duty ball corners, hinged lids, and stacking caster plates. The FZTP1WBL features stacking caster plates for stacking two FZTP2WBL cases or another FZTP1WBL case on top.



FZTP2WBL



FZTP1WBL

(Lids feature stacking caster plates)

Flight Zone Series:

MODEL	DIMENSIONS	INT. DIMENSIONS	WEIGHT
FZUTWBL	45.75" x 32" x 30.5"	43" x 27.75" x 24"	136 lbs.
FZTP1WBL	47" x 31" x 24.5"	46" x 27.5" x 21.5"	90 lbs.
FZTP2WBL	23.5" x 35.5" x 23.5"	21.5" x 27.5" x 21.5"	59 lbs.

CD/DIGITAL MEDIA PLAYER CASES - DESIGNER DJ™



CD/DIGITAL MEDIA CD PLAYERS CASES

Odyssey's Designer DJ™ Series offer a unique twist in flight case design for DJs who want to make a statement that screams louder than COOL. Available in Blue on Black or Red on Black, these cases are built tough to the exact standards and product protection as our Flight Ready® series of cases except all the hardware used in the build of these slick cases are powder coated and anodized in BLACK.



FRCDJBKBLUE



*width adjustment
foam included



FRCDJBKRED

Large format CD/Digital DJ Coffins
fit players such as:
Denon SC5000 PRIME
Gemini CDJ-700, MDJ-1000
Pioneer CDJ-850/900NXS, XDJ-1000MK2
Reloop RMP-4

MODEL	DIMENSIONS	WEIGHT	FITS
FRCDJBKBLUE	15" x 9.5" x 20"	13 lbs.	Large format CD/Digital Media player
FRCDJBKRED	15" x 9.5" x 20"	13 lbs.	Large format CD/Digital Media player

*Flight Ready cases are not made to fit the Pioneer CDJ-2000 players.

DJ MIXER & TURNTABLE CASES - DESIGNER DJ™ SERIES



DJ MIXER CASES



FR10MIXBKRED



FR12MIXBKBLUE

MODEL	DIMENSIONS	WEIGHT	FITS
FR10MIXBKBLUE	21" x 9.38" x 12.75"	11 lbs.	most 10" format mixers
FR10MIXBKRED	21" x 9.38" x 12.75"	11 lbs.	most 10" format mixers
FR12MIXBKBLUE	14.5" x 8.75" x 20.5"	12 lbs.	most 12" format mixers
FR12MIXBKRED	14.5" x 8.75" x 20.5"	12 lbs.	most 12" format mixers



TURNTABLE CASES



FR1200BKBLUE



FR1200BKRED

MODEL	DIMENSIONS	WEIGHT	FITS
FR1200BKBLUE	20.25" x 9.25" x 17.25"	13 lbs.	1200 style turntables
FR1200BKRED	20.25" x 9.25" x 17.25"	13 lbs.	1200 style turntables

*Our turntable cases can hold Numark, Pioneer, Stanton, as well as Technics 1200 style turntables.

TURNTABLE COFFINS BATTLE STYLE



FZBM12W

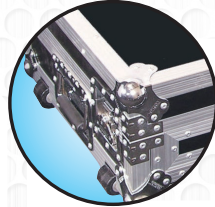

Recessed Rollers
for easy
transportation

Flight Zone Series:

MODEL	DIMENSIONS	WEIGHT	FITS
FZBM10W	47" x 9" x 22.5"	53 lbs.	10" format mixer, (2) 1200 style turntables in Battle position
FZBM12W	49" x 9" x 22.5"	56 lbs.	12" format mixer, (2) 1200 style turntables in Battle position

*Our turntable coffins can hold Numark, Pioneer, Stanton, as well as Technics 1200 style turntables!

STANDARD POSITION



FZDJ10W

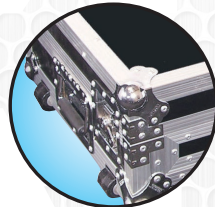

Recessed Rollers
for easy
transportation

FZDJ19W



FZDJ12W

Flight Zone Series:

MODEL	DIMENSIONS	WEIGHT	FITS
FZDJ10W	46" x 8" x 22"	53 lbs.	10" format mixer, (2) 1200 style turntables in Standard position
FZDJ12W	48" x 8" x 22"	55 lbs.	12" format mixer, (2) 1200 style turntables in Standard position
FZDJ19W	61" x 8.25" x 20.7"	59 lbs.	19" rack mount mixer, 8U rack, (2) 1200 style turntables in Standard position

*Our turntable coffins can hold Pioneer, Numark, Stanton, as well as Technics 1200 style turntables!

CD/DIGITAL MEDIA DJ COFFINS • LARGE FORMAT

Our CD/Digital media DJ Coffins hold two large format tabletop CD/Digital Media players and one 10", 12", or 19" format mixer. These ATA Rolling Coffins feature rugged built-in rollers, heavy-duty spring-loaded handles, butterfly latches, and front access panels. Cabling is clean and easy through convenient access ports throughout.

Large format CD/Digital DJ Coffins fit players such as:
Denon SC5000 PRIME
Gemini CDJ-700, MDJ-1000
Pioneer CDJ-850/900NXS/2000NXS2, XDJ-1000MK2
Reloop RMP-4



FZ12CDJWXD



FZ10CDJW

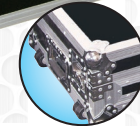

Recessed Rollers
for easy
transportation

Flight Zone Series:

MODEL	DIMENSIONS	WEIGHT	FITS
FZ10CDJW	34.5" x 9" x 18.5"	38 lbs.	10" format mixer, (2) large format CD/Digital Media Players
FZ12CDJW	43" x 9.5" x 19"	40 lbs.	12" format mixer, (2) large format CD/Digital Media Players
FZP122000W	47.5" x 9.25" x 21"	50 lbs.	Pioneer DJM-2000 mixer, (2) large format CD/Digital Media Players
FZ12CDJWXD	45" x 9" x 21.25"	42 lbs.	Extra Deep 12" format mixer, (2) large format CD/Digital Media Players

Flight Ready Series:

MODEL	DIMENSIONS	WEIGHT	FITS
FR10CDJWE	41" x 9.5" x 19.5"	34 lbs.	10" format mixer, (2) large format CD/Digital Media Players
FR12CDJWE	43" x 9.5" x 19"	38 lbs.	12" format mixer, (2) large format CD/Digital Media Players

Flight Ready series coffins are not designed to hold Pioneer CDJ-2000 players

CD/DIGITAL MEDIA DJ COFFINS
MEDIUM FORMAT

PIONEER CD/ DIGITAL
MEDIA DJ COFFINS



FZ12CDiW



**width adjustment
foam included*

Medium format CD/Digital DJ coffins
fit players such as:
Gemini CDJ-300/650
Numark NDX200/500
Pioneer CDJ-350/XDJ-700
Stanton CMP.800

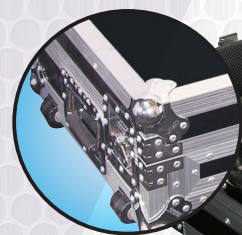

*Recessed Rollers
for easy transportation*



FZ19CDiW

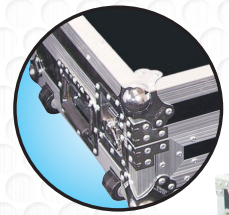

*Recessed Rollers
for easy transportation*



FZGS22000W



FZP122000W



FZGSP22000W



Flight Zone Series:

MODEL	DIMENSIONS	WEIGHT	FITS
FZ10CDiW	34.5" x 9" x 19"	38 lbs.	10" format mixer, (2) medium format CD/Digital Media Players
FZ12CDiW	36.5" x 9" x 19"	39 lbs.	12" format mixer, (2) medium format CD/Digital Media Players
FZ19CDiW	43" x 9.5" x 19.5"	43 lbs.	19" rack mount mixer, (2) medium format CD/Digital Media Players

Flight Ready Series:

MODEL	DIMENSIONS	WEIGHT	FITS
FR10CDiWE	34.5" x 9" x 19"	37 lbs.	10" format mixer, (2) large format CD/Digital Media Players
FR12CDiWE	36.75" x 9" x 19.25"	39 lbs.	12" format mixer, (2) large format CD/Digital Media Players

Flight Zone Series:

MODEL	DIMENSIONS	WEIGHT	FITS
FZP122000W	47.5" x 9.25" x 21"	50 lbs.	Pioneer DJM-2000 Mixer, (2) large format CD/Digital Players
FZGSP22000W*	50" x 10" x 22"	55 lbs.	Pioneer DJM-2000 Mixer, (2) large format CD/Digital Players * (full width glide platform)
FZGS22000W*	47.25" x 12.75" x 21.25"	59 lbs.	Pioneer DJM-2000 Mixer, (2) large format CD/Digital Players * (two tier glide platform)

LARGE FORMAT GLIDE STYLE™ CD/DIGITAL MEDIA DJ COFFINS

Our Glide Style™ Coffins hold two tabletop CD/Digital Media players and one mixer. Dual tier versions feature a slide-out shelf under the laptop platform for wireless mics, laptop interfaces, external hard drives, or other essential digital DJ gear.



FZGS12CDJW
12" Mixer Large Format
CD/Digital Media DJ Coffin

FZGSL12CDJW
12" Mixer Large Format
CD/Digital Media DJ Coffin



Large format CD/Digital DJ Coffins
fit players such as:
Denon SC5000 PRIME
Gemini CDJ-700, MDJ-1000
Pioneer CDJ-850/900NXS/2000NXS2, XDJ-1000MK2
Reloop RMP-4

Flight Zone Series:

MODEL	DIMENSIONS	WEIGHT	FITS
FZGS12CDJW	42.5" x 13" x 19"	49 lbs.	12" format mixer, (2) large format CD/Digital Media player
FZGS22000W	47.25" x 12.75" x 21.25"	59 lbs.	DJM-2000 mixer, (2) large format CD/Digital Media player
FZGSL12CDJW	44.5" x 8.75" x 20.75"	43 lbs.	12" format mixer, (2) large format CD/Digital Media player

*These cases are not designed to transport laptops

GSX GLIDE STYLE™ CD/DIGITAL MEDIA DJ COFFIN



FZGSX12CDJW



Large format CD/Digital DJ Coffins
fit players such as:
Denon SC5000 PRIME
Gemini CDJ-700, MDJ-1000
Pioneer CDJ-850/900NXS/2000NXS2, XDJ-1000MK2
Reloop RMP-4

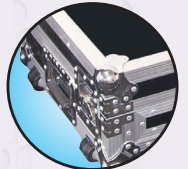

Recessed Rollers
for easy
transportation



width adjustment foam
included



Featuring lockable laptop
compartment

Odyssey's GSX Glide Style™ Series DJ coffins feature the ability to safely store your laptop inside the actual laptop platform that sits right above the mixer compartment. To access the compartment, the top section slides open left and right and includes key locks for added security allowing the DJ to take a break from the booth without having to worry about theft. Just another innovative design to the Glide Style™ case family. Also available in Black Label™ Series .

Flight Zone Series:

MODEL	DIMENSIONS	WEIGHT	FITS
FZGSX12CDJW	42.75" x 12.25" x 19.5"	52 lbs.	12" format mixer, (2) large format CD/Digital Media players

*These cases are not designed to transport laptops

Remixer™ FULL WIDTH GLIDE STYLE™ DJ COFFINS

As the evolution of the DJ continues, so do the designs of Odyssey DJ coffins. Introducing the REMIXER™ GLIDE STYLE™ SERIES DJ coffins featuring a full width glide platform to place all your DJ remix gear. With digital vinyl software such as Serato and Traktor Scratch, more DJs have gone through the transition from beat mixer to full on remixer producer. Availability of so many affordable remixing tools to the DJ, such as midi keyboards and controllers to laptops and iPads, has grown to an ultimate high and Odyssey is there in the middle of it all providing DJs the most functional DJ coffins yet with the REMIXER™ GLIDE STYLE™ SERIES. Also available in Black Label™ Series.



*width adjustment foam included



Recessed Rollers for easy transportation

Large format CD/Digital DJ Coffins fit players such as:
 Denon SC5000 PRIME
 Gemini CDJ-700, MDJ-1000
 Pioneer CDJ-850/900NXS/2000NXS2, XDJ-1000MK2
 Reloop RMP-4

FZGSP22000W
 Pioneer DJM-2000 Mixer CD/Digital Media DJ Coffin



FZGSP12CDJW
 12" Format Mixer Large Format CD/Digital Media DJ Coffin



FZGSP19CDJW
 19" Rack mount Mixer CD/Digital Media DJ Coffin



*width adjustment foam included

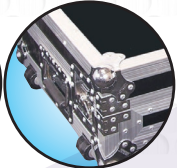

Recessed Rollers for easy transportation

FZGSPDJ10W



FZGSPBM12W
 Battle position DJ Coffin.



*Our turntable coffins can hold Pioneer, Numark, Stanton, as well as Technics 1200 style turntables

Flight Zone Series:

MODEL	DIMENSIONS	WEIGHT	FITS
FZGSP10CDJW	42.5" x 10.13" x 21"	50 lbs.	10" format mixer, (2) Large Format CD/Digital Media Players
FZGSP12CDJW	45" x 10.63" x 21"	52 lbs.	12" format mixer, (2) Large Format CD/Digital Media Players
FZGSP19CDJW	50.5" x 10.63" x 21"	56 lbs.	19" rack mount mixers (2) Large Format CD/Digital Media Players
FZGSP22000W	50" x 10" x 22"	55 lbs.	Pioneer DJM-2000 mixer, (2) CD/Digital Media Players
FZGSPBM10W	47.25" x 10.5" x 24.25"	56 lbs.	10" format mixer, (2) Turntable in Battle Position
FZGSPBM12W	49.5" x 10.5" x 24.25"	58 lbs.	12" format mixer, (2) Turntable in Battle Position
FZGSPDJ10W	54.5" x 10.5" x 21"	66 lbs.	10" format mixer, (2) Turntables in Standard Position
FZGSPDJ12W	56.5" x 10.5" x 21"	65 lbs.	12" format mixer, (2) Turntables in Standard Position
FZGSPDJ19W	63.25" x 10.5" x 21"	67 lbs.	19" rack mount mixer, (2) Turntables in Standard Position

*These cases are not designed to transport laptops.

GLIDE STYLE™ TURNTABLE DJ COFFINS



FZGSLBM12WR
(Battle Mode)



Recessed Rollers
for easy
transportation

FZGSDJ19WR
(Standard Mode)



Flight Zone Series:

MODEL	DIMENSIONS	WEIGHT	FITS
FZGSLDJ12W	56" x 9" x 20"	47 lbs.	12" format DJ Mixer and 2 Turntables in standard position
FZGSDJ19WR	62.5" x 12.5" x 19.5"	64.6 lbs.	19" rack mount, (2) 1200 style turntables in standard position, single tier laptop glide platform with 1U rack rail underneath
FZGSLBM12WR	48" x 9" x 23.75"	55 lbs.	12" format mixer, (2) 1200 style turntables in battle mode
FZGSLBM10WR	46" x 9" x 23.5"	53 lbs.	10" format mixer, (2) 1200 style turntables in battle mode

*Our turntable coffins can hold Pioneer, Numark, Stanton, as well as Technics 1200 style turntables



FZLP80

CD/5" MEDIA DISC & VINYL RECORD/UTILITY CASES



FZCD320



FZCD480



FZ45120

Flight Zone LP Cases:

MODEL	DIMENSIONS	WEIGHT	FITS
FZ45120	20" x 11" X 11"	12 lbs.	approx. 120 45's
FZLP80	15" x 15" x 15"	22 lbs.	approx. 80 LPs
FZLP120HW	22" x 17" x 18"	32 lbs.	approx. 120 LPs (w/recessed rollers and pullout handle)

Flight Zone CD Cases:

MODEL	DIMENSIONS	WEIGHT	FITS
FZCD320	26" x 9" x 16"	19 lbs.	approx. 320 viewpack CDs, 106 jewel cases
FZCD480	39" x 9" x 16.5"	36 lbs.	approx. 480 viewpack CDs, 160 jewel cases

TURNTABLE CASES



FR1200E
Flight Ready Series



FTTDIA



FZ1200
Flight Zone Series

FZ1200BL
Flight Zone Series



Our turntable cases can hold Numark, Pioneer, Stanton, as well as Technics 1200 style turntables!

MODEL	DIMENSIONS	WEIGHT
FR1200E	20.25" x 9.25" x 17.25"	17 lbs.
FTTDIA	22" x 9" x 18"	18 lbs.
FZ1200	21.5" x 9.5" x 21.5"	20 lbs.
FZ1200BL	21.5" x 9.5" x 21.5"	20 lbs.

FLIGHT STYLE TURNTABLE CASES

FTTXBLK



FTTX*

- *Available in black, red, or blue
- 21" x 9.5" x 17.5", 20 lbs.
- FTTX cases can hold Pioneer, Numark, Stanton, as well as Technics 1200 style turntables!

DJ MIXER CASES



FZ10MIXXD



FZ19MIX
(10 rack spaces)



FZ10MIXDIA



FZ12MIX

Travel in style and security with our ATA DJ Mixer Cases. They fit most popular DJ mixer sizes and feature a high quality foam-lined interior. The 10" version features a removable front access panel and fits mixers 8.75" to 10.75" wide, up to 15" deep, and 3" tall. The 19" version has up to 10 spaces for gear 4.5" to 6.125" tall (base to peak). Also available in Black Label™ Series. .

Flight Zone Series:

MODEL	Dimensions	WEIGHT	FITS
FZ10MIX	13" x 9.5" x 21.5"	18 lbs.	most 10" format mixers
FZ10MIXDIA	13" x 9.5" x 21.5"	18 lbs.	most 10" format mixers
FZ10MIXXD	14.25" x 8.25" x 21.75"	17 lbs.	most 10" format mixers, extra deep rear cable space
FZ12MIX	15.5" x 9.5" x 19.5"	19 lbs.	most 12" format mixers
FZ12MIXDIA	15.5" x 9.5" x 19.5"	19 lbs.	most 12" format mixers
FZ12MIXXD	16.25" x 8.25" x 22.75"	19 lbs.	most 12" format mixers, extra deep rear cable space
FZ19MIX	21.5" x 8.5" x 17"	20 lbs.	19" rack mount mixer 10u
FZDJM2000	22" x 10" x 21"	20 lbs.	Pioneer DJM-20000

Flight Ready Series:

MODEL	Dimensions	WEIGHT	FITS
FR10MIXE	12.75" x 9.38" x 21"	11 lbs.	most 10" format mixers
FR12MIXE	14.5" x 9.38" x 20.5"	12 lbs.	most 12" format mixers

GLIDE STYLE™ DJ MIXER CASES

Our family of Patented Glide Style™ Mixer cases are the most sought after DJ mixer cases in the industry. Our 10" & 12" mixer versions are designed with an extra deep cable well area for plenty of room for power supplies as well as cables. Black Label™ versions are also available.



FZGS10MX1



FZGS12MX1



FZGSDJM2000



FZGS12RANE64

*Extra wide front access panel

MODEL	DIMENSIONS	WEIGHT	FITS
FZGS10MX1	15.5" x 8.5" x 20.25"	21 lbs.	most 10" format mixers
FZGS12MX1	17" x 8.25" x 20"	21 lbs.	most 12" format mixers
FZGS12RANE64	17" x 8.75" x 20"	21 lbs.	most 12" format mixers and Rane 64/68/MP2015
FZGSDJM2000	22" x 9" x 22"	26 lbs.	Pioneer DJM-2000 and most 12" format mixers

*These cases are not designed to transport laptops.

CD/DIGITAL MEDIA MIXER CASE



FZGS8CDMIX
shown with the
Denon DN-MC6000



also fits rack mount front load dual CD/digital media players such as the Numark iCDMIX or CDMix Bluetooth

10U Rackable Space

The FZGS8CDMIX Flight Zone® case is the ideal case for standard 19" rack mountable front load CD/Digital Media Mixers and DJ controllers. The slanted V-Cut™ removable front panel gives you plenty of access to the front load disc slots of a Dual CD/MP3 System or the control knobs, headphone jack, and switches of a Denon DN-MC6000MK2 DJ controller when used with its rack mount kit. The FZGS8CDMIX features Odyssey's patented gliding laptop platform great for positioning your laptop over the rack gear where it best suits you. Another perfect pro case for a DJ's pro gear.

Features:

- Removable Front V-CUT™ Access Panel with a 16" opening
- Patented Gliding Laptop Platform (20"W x 12"D)
- Heavy-Duty Ball Corners
- Recessed Handle and Latches
- Rubber Feet
- 10U Rackable Space
- Limited Lifetime Warranty

Specs:

- Rack Rail Height is: 3.75" Front & 5.75" Back
- Front to Back Depth is 19"

Flight Zone Series:

MODEL	DIMENSIONS	WEIGHT	RACKABLE SPACE
FZGS8CDMIX	22" x 12.5" x 20.75"	29 lbs.	10U

*This case is not designed to transport laptops.

CD/DIGITAL MEDIA PLAYER CASES

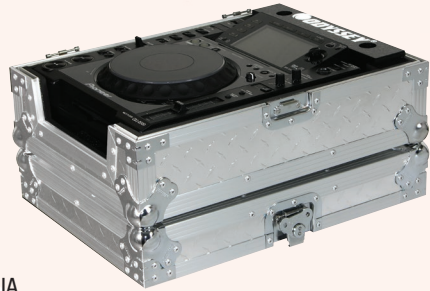

FZCJDIA
Large format CD/Digital Media Player Case



FZCDJ
Large format CD/Digital Media Player Case

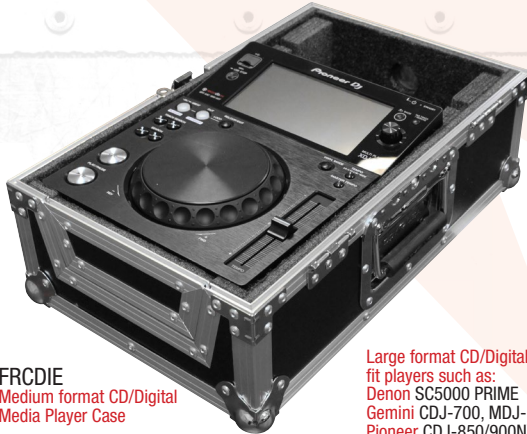

FRCJDIE
Medium format CD/Digital Media Player Case



FRCDJJE
Large format CD/Digital Media Player Case

Large format CD/Digital DJ Coffins fit players such as:
Denon SC5000 PRIME
Gemini CDJ-700, MDJ-1000
Pioneer CDJ-850/900NXS/2000NXS2, XDJ-1000MK2
Reloop RMP-4

Medium format CD/Digital DJ coffins fit players such as:
Gemini CDJ-300/650
Numark NDJ200/500
Pioneer CDJ-350/XDJ-700
Stanton CMP.800

Flight Zone Series:

MODEL	DIMENSIONS	WEIGHT	FITS
FZCDJ	15" x 9" x 19"	17 lbs.	large format CD/Digital Media Player
FZCJDIA	15" x 9" x 19"	17 lbs.	large format CD/Digital Media Player

Flight Ready Series:

MODEL	DIMENSIONS	WEIGHT	FITS
FRCJDIE	11.75" x 9" x 18.5"	10 lbs.	medium format CD/Digital Media Player
FRCDJJE*	14.75" x 8.25" x 19"	17 lbs.	large format CD/Digital Media Player

*Flight Ready cases are not made to fit Pioneer CDJ-2000 players

SHALLOW DEPTH EFFECTS RACKS



FZER2
12.25" rail to rail
15.75" rail to cover



FZER6
12.25" rail to rail
15.75" rail to cover



FZER8HW
Convenient pull-out handle



FZER4HW
With Wheels and Pull-Out Handle



Recessed rollers for easy transportation

Flight Zone Series:

MODEL	DIMENSIONS	WEIGHT	SPACES
FZER2	21.5" x 5.5" x 21.25"	17 lbs.	2U
FZER4	21.5" x 9" x 21.25"	26 lbs.	4U
FZER4HW	21.5" x 11" x 21.25"	34 lbs.	4U
FZER6	21.5" x 12.75" x 21.25"	28 lbs.	6U
FZER6HW	21.5" x 14" x 21.25"	36 lbs.	6U
FZER8HW	21.5" x 17.5" x 21.25"	39 lbs.	8U

Flight Ready Series:

MODEL	DIMENSIONS	WEIGHT	SPACES
FRER2	21.5" x 5.5" x 20"	15 lbs.	2U
FRER4	21.5" x 9.25" x 20"	19 lbs.	4U
FRER6	21.5" x 14.25" x 20"	20 lbs.	6U
FRER8	21.5" x 15.5" x 20"	22 lbs.	8U

Our ATA Effects Racks feature dual rack rails (front and rear), heavy-duty steel ball corners, spring-loaded handles, and removable front and rear covers. They're built to last under rigorous transporting. Our Rolling Racks feature low profile, super-strong recessed rollers, and a pull-out handle for superior convenience. These sturdy ATA cases accommodate all standard 19" rack mount equipment and feature front and back rails.

AMP RACKS



FZAR20W
Dolly plate included in "W" models

Flight Zone Series:

These sturdy, ATA Amp Racks incorporate dual rack rails (front and rear), heavy-duty rubber feet (non-wheeled versions), spring-loaded handles, and removable front and rear covers. Designed to protect and transport larger amps and other standard 19" rack mount gear.

- Internal Depth (Rail to Rail): 16.5"
- Internal Depth (Rail to Cover): 19.75"



FZAR4



FZAR10

Optional



FZADP
Available as an option for only non-wheeled FZ series models

Flight Zone Series:

MODEL	DIMENSIONS	WEIGHTS	SPACES
FZAR2	21.5" x 7.5" x 25.25"	18 lbs.	2U
FZAR4	21.5" x 10.5" x 25.25"	23 lbs.	4U
FZAR6	21.5" x 13.5" x 25.25"	28 lbs.	6U
FZAR8	21.5" x 16.5" x 25.25"	36 lbs.	8U
FZAR10	21.5" x 19.5" x 25.25"	44 lbs.	10U
FZAR12	21.5" x 22.5" x 25.25"	52 lbs.	12U
FZAR12W	21.5" x 25.25" x 25.25"	67 lbs.	12U (dolly plate included)
FZAR14W	21.5" x 26" x 25.25"	59 lbs.	16U
FZAR16	21.5" x 30" x 25.25"	56 lbs.	16U
FZAR16W	21.5" x 29.5" x 25.25"	74 lbs.	16U (dolly plate included)
FZAR20W	21.5" x 37.5" x 25.25"	85 lbs.	20U (dolly plate included)

Flight Ready Series:

MODEL	DIMENSIONS	WEIGHT	SPACES
FRAR2E	21.25" x 5.5" x 23.75"	17 lbs.	2U
FRAR4E	21.25" x 9.25" x 23.75"	19 lbs.	4U
FRAR6E	21.25" x 12.5" x 23.75"	21 lbs.	6U
FRAR8E	21.25" x 15.75" x 23.75"	27 lbs.	8U
FR16WE	21.25" x 34.5" x 23.75"	52 lbs.	16U (dolly plate included)

Specifically designed for touring professionals and seasoned sound engineers, Shock Mount Racks provide the ultimate in protection for sensitive gear as well as heavy loads. Each internal rack is surrounded with thick high-density EVA foam and features front and rear rack rails, heavy-duty recessed chrome-plated steel hardware, spring-loaded handles, and 3/8" ply laminated shells. Specifically designed to withstand the abuse of life on the road. Available in 6 sizes.



20" rail to cover
16.5" rail to rail



Flight Zone Series

MODEL	DIMENSIONS	WEIGHT	SPACE
FZS02	24" X 8.5" X 26.5"	42 lbs.	2U
FZS04	24" X 12" X 26.5"	47 lbs.	4U
FZS06	24" X 15.5" X 26.5"	52 lbs.	6U
FZS08	24" X 19" X 26.5"	57 lbs.	8U
FZS12W*	24" X 32" X 26.5"	67 lbs.	12U
FZS14W*	24.25" X 35.25" X 28"	91 lbs.	14U

*INCLUDES DOLLY PLATE

SHOCK MOUNT RACKS



D.I.Y SPACE SAVER™ AMP RACKS & COMBO RACKS



Ships compact



Slide in side panels

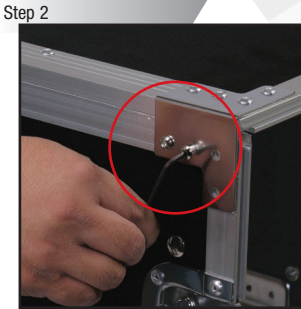

Fasten your screws in place



Attach dolly plate



Ready to Go!

Easy To Assemble Racks

FZSRPAR16W



FZSRP1116W



Features:

- Heavy-duty ball corners
- Recessed Latches and handles
- Aluminum tongue and groove frames to insure proper door fit
- Heavy-duty 4" casters (2 w/brakes)
- 17" interior body depth (rail to rail)
- 3" Covers
- Front and back rack rails

Flight Zone Series Amp Racks

MODEL	DIMENSIONS	INT. DEPTH (Rail to rail)	WEIGHT	VERT.
FZSRPAR12W	21.5" X 26." X 25.25"	17"	74 lbs.	12U
FZSRPAR16W	21.5" X 29.5" X 25.25"	17"	93 lbs.	16U
FZSRPAR20W	21.5" X 37.5" X 25.25"	17"	122 lbs.	20U

Flight Zone Series Combo Racks

MODEL	DIMENSIONS	INT. DEPTH (Rail to rail)	WEIGHT	SLANT	VERT.
FZSRP1112W	21.5" X 37.25" X 28.5"	17"	78 lbs.	11U	12U
FZSRP1116W	21.5" x 45" x 28.5"	17"	96 lbs.	11U	16U

Our ATA Combo Racks give you the best of both worlds. Mount mixers and controllers on top for convenient access and all other essentials below. "W" versions feature heavy-duty casters on a dolly plate (front casters feature sure stop brakes) while the "DLX" versions I and II feature lids that turn into side mount workstations.



FZ1116WDLX

Dolly Plate included on "W" models



FZ1002



FZ1116WDLX-II
Features dual side tables

Flight Zone Series:

MODEL	DIMENSIONS	WEIGHT	SLANT	VERT.
FZ1002	21.5" x 15" x 24"	37 lbs.	10U	2U
FZ1004	21.5" x 18.5" x 24"	40 lbs.	10U	4U
FZ1006	21.5" x 23" x 24"	43 lbs.	10U	6U
FZ1008	21.5" x 25" x 24"	46 lbs.	10U	8U
FZ1012	21.5" x 31" x 24"	56 lbs.	10U	12U
FZ1014W	21.5" x 34" x 24"	66 lbs.	10U	14U
FZ1016W	21.5" x 44" x 24"	75 lbs.	10U	16U
FZ1108	21.5" x 25" x 24"	50 lbs.	11U	8U
FZ1112W	21.5" x 37.25" x 28"	75 lbs.	11U	12U
FZ1112WDLX	21.5" x 37.25" x 28"	83 lbs.	11U	12U
FZ1116W	21.5" x 45" x 28.5"	85 lbs.	11U	16U
FZ1116WDLX	21.5" x 44.25" x 26"	85 lbs.	11U	16U
FZ1116WDLXII	21.5" x 45" x 28"	95 lbs.	11U	16U
FZ1214WDLX-II	21.5" x 41" x 31.25"	100 lbs.	12U	14U
FZ1316W	21.5" x 45" x 28.5"	101 lbs.	13U	16U
FZ1316WDLX	21.5" x 45" x 28.5"	108 lbs.	13U	16U
FZ1316WDLX-II	21.5" x 44.75" x 33.5"	104 lbs.	13U	16U

FZ1116W



FR0804

Flight Ready Series:

MODEL	DIMENSIONS	WEIGHT	SLANT	VERT.
FR0802	21" x 14.75" x 19.5"	25 lbs.	8U	2U
FR0804	21" x 18.25" x 19.5"	27 lbs.	8U	4U
FR0806	21" x 21.75" x 19.5"	30 lbs.	8U	6U
FR1002	21" x 14" x 22.5"	27 lbs.	10U	2U
FR1004	21" x 18.25" x 22.75"	30 lbs.	10U	4U
FR1006	21" x 22" x 23"	33 lbs.	10U	6U
FR1014W	21" x 36.25" x 23.25"	62 lbs.	10U	14U
FR1016W	21" x 39.75" x 23.25"	65 lbs.	10U	16U



Optional
FZWMP
Compatible With the Following Flight Zone® Combo Racks:
FZ1002, FZ1004, FZ1006, FZ1008, FZ1012

THE ORIGINAL GLIDE STYLE™ COMBO RACKS

Our Glide Style™ Combos feature our patented sliding laptop platform above a 19" slanted rack mount section. At your gig, set your laptop on the carpeted surface, plug in and you're ready to go. Slide it forward to use your laptop. Slide it back to use the mixer section underneath. Keep your laptop close and safe on a sturdy new Glide Style™ Combo case.



Flight Zone Series:

MODEL	DIMENSIONS	WEIGHT	SLANT	VERT.
FZGS1002	23" x 16.25" x 24.5"	46 lbs.	10U	2U
FZGS1004	22.25" x 18.5" x 23.75"	44 lbs.	10U	4U
FZGS1304	22.25" x 21" x 28.5"	54 lbs.	13U	4U
FZGS1116W	22.25" x 45.25" x 28.5"	92 lbs.	11U	16U
FZGS1116WDLX	22.25" x 45.25" x 28.5"	103 lbs.	11U	16U
FZGS1214WDLX-II	22" x 45" x 31.25"	115 lbs.	12U	14U
FZGS1316WDLX	22.25" x 48.5" x 28.5"	111 lbs.	13U	16U

*These cases are not designed to transport laptops.

Flight Ready Series:

MODEL	DIMENSIONS	WEIGHT	SLANT	VERT.
FRGS802	22" x 15.75" x 23"	21 lbs.	8U	2U
FRGS804	22" x 18.25" x 23"	33 lbs.	8U	4U
FRGS806	22" x 22" x 23"	37 lbs.	8U	6U
FRGS1016WDLX	22" x 44.5" x 23"	77 lbs.	16U	16U

*These cases are not designed to transport laptops.



FZGS1004



FZWIRELESS

Our Flight Zone® series wireless mic case features a fully diced foam interior so you can tailor the inside to fit your wireless mic gear. Because the interior is diced foam, this case can be used for other gear as well!

MICROPHONE CASES

The Flight Zone® series FZSHQLXD1 wireless mic case is specifically made to fit the Shure Wireless Mic Bodypack Transmitter system with custom fit foam drop spaces to hold everything you need in perfect place in storage or transport. Features include key locking latches, an egg foam lined interior lid, sturdy briefcase style carrying handle, and rubber feet.



FZSHQLXD1



FZMIC12

Our FZMIC microphone cases feature a foam interior, recessed butterfly latch w/padlock loop, recessed handle, and sturdy ball corners. They hold a maximum of either 12 or 18 microphones and have a lockable interior cable compartment.



FZMIC18

Flight Zone Series:

MODEL	DIMENSIONS	WEIGHT	FITS
FZMIC12	16" x 17" x 12"	20 lbs.	12 microphones and cables
FZMIC18	22.75"x15.75"x 11"	16 lbs.	18 microphones and cables
FZSHQLXD1	19" x 4.75" x 18"	11 lbs.	Shure QLXD1 wireless mic system
FZWIRELESS	19" x 4.75" x 18"	11 lbs.	Customizable Pluck Foam Interior for Wireless Mic Gear

GUITAR COMBO AMP CASES

GUITAR COMBO AMP CASES



FZGC212W



FZGC410W

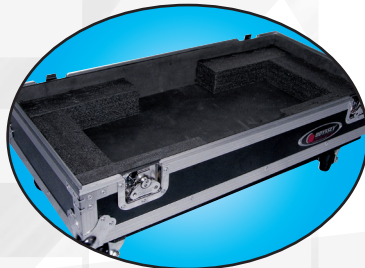

Adjustable Interlocking Foam

Tired of your combo amp getting banged around or busted up? Our ATA Guitar Combo Amp cases are the perfect solution for safely transporting your 1x12, 2x12, and 410 combo amp. Each case features heavy-duty handles, casters, and latches for the ultimate in protection. The interlocking foam inserts allow you to customize the fit for most amps. Check the specs below to see if your amp will fit. For custom fit guitar amp cases check out our custom case division at www.BCcases.com

*Custom made cases are also available for your specialty amp.

Flight Zone Series:

MODEL	EXT. DIMENSIONS	INT. DIMS	WEIGHT	FITS
FZGC112W	29" x 32" x 16.5"	27" x 22" x 14.3"	58 lbs.	1 x 12 Guitar Amps
FZGC212W	34" x 31" x 17.75"	31.75" x 24" x 15.5"	65 lbs.	2 x 12 Guitar Amps
FZGC410W	26.5" x 32" x 14.75"	24" x 24" x 12"	52 lbs.	410 combo head

GUITAR AMP HEAD & SPEAKER CABINET CASES

GUITAR AMP HEAD & SPEAKER CABINET CASES



FZGAMPHEAD1



FZGAMPHEAD2X2W



Flight Zone Series:

MODEL	EXT. DIMENSIONS	INT. DIMS	WEIGHT	FITS
FZG412W	32.25" x 37" x 19"	29.75" x 29" x 16.5"	65 lbs.	412 speaker cabinet w/casters
FZG412LW	38" x 42" x 23"	34.5" x 33.5" x 20.25"	70 lbs.	412 speaker cabinet w/casters
FZGAMPHEAD1	32" x 14.5" x 13"	30.25" x 12" x 10"	31 lbs.	fits 1 guitar amp heads
FZGAMPHEAD2X2W	32.75" x 34.5" x 20.25"	30.25" x 12" x 10"	81 lbs.	fits 2 guitar amp heads

Protect all your valuable guitar gear with our ATA Guitar Amp and Speaker Cabinet Cases. Their heavy-duty construction keeps your expensive gear safe, gig after gig. Each case features recessed steel latches and spring-loaded handles. For custom fit guitar amp head and speaker cabinet cases check out our custom case division at www.BCcases.com



FZG412LW

GUITAR PEDAL BOARD CASES



FZGPEDAL24

Our Pedal Board Cases include a removable plate with hook and loop straps. These ATA cases allow the professional musician or stage technician the best solution for gear protection on the go.



FZGPEDAL32W
(with recessed rollers)

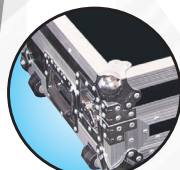

*Recessed
Rollers
for easy
transportation*



FZGPEDAL17

Flight Zone Series:

MODEL	DIMENSIONS	WEIGHT	FITS
FZGPEDAL17	19.25" x 9.5" x 19.5"	20 lbs.	pedals up to 17" wide on a removable plate
FZGPEDAL24	25.5" x 9.5" x 19.5"	25 lbs.	pedals up to 24" wide on a removable plate
FZGPEDAL32W	39.75" x 9.5" x 19.5"	30 lbs.	pedals up to 32" wide on a removable plate (features rollers)

FZKB37



FZKB49W



KEYBOARD CASES AND ACCESSORIES

Our heavy-duty ATA Keyboard Cases can handle the harsh realities of life on tour as well as constant short haul transport. "W" versions come equipped with recessed rollers for easier transport of heavier keyboards. For custom fit keyboard cases check out our custom case division at www.BCcases.com

FZKB61W



Flight Zone Series:

MODEL	EXT. DIMENSIONS	WEIGHT	INT. DIMENSIONS	FITS
FZKB31	29.2" x 8.2" x 18.9"	18 lbs.	26" x 4.5" x 14.5"	most 31-note keyboards
FZKB37	38" x 9" x 18"	32 lbs.	36" x 6.5" x 15"	most 37-note keyboards
FZKB49W	41.75" x 9.25" x 18.5"	38 lbs.	38.5" x 6.25" x 15.25"	most 49-note keyboards
FZKB61W	49" x 10" x 20"	43 lbs.	43.3" x 7" x 16.5"	most 61-note keyboards
FZKB76W	56" x 10" x 20"	52 lbs.	51.3" x 7" x 17"	most 76-note keyboards
FZKB88W	63" x 10" x 24"	63 lbs.	58.3" x 7" x 21"	most 88-note keyboards

Fold it up and go!



ASCK61

MODEL	FITS
ASCK61	stretch cover for most 61-note keyboards
ASCK76	stretch cover for most 76-note keyboards
ASCK88	stretch cover for most 88-note keyboards

KEYBOARD STRETCH COVERS

Each comes with a handy bag





FZTF1

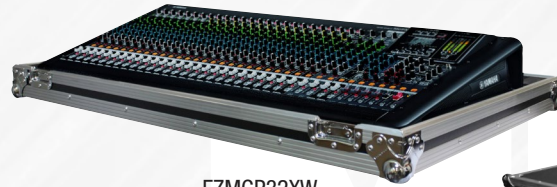

FZMGP32XW



FZMIDM32DHW
(with doghouse & caster wheels)

Our heavy-duty Live Sound Mixing Console Cases can handle the harsh realities of life on tour as well as constant short haul transport. If you don't see your mixer listed, call us and we'll build you a case for it. For custom fit live sound mixing console cases check out our custom case division at www.BCCases.com

Flight Zone Series:

MODEL	EXT. DIMS	INT. DIMS	WEIGHT	FITS
ALLEN & HEATH				
FZ240024W	38.75" x 9.25" x 28"	36" x 7" x 22.5"	51 lbs.	Allen & Heath 240024 Mixer (w/recessed rollers)
FZQU24W	29" x 11" x 25"	24.9" x 9" x 19.7"	51 lbs.	Allen & Heath QU24 Mixer (w/recessed rollers)
FZQU32W	37.5" x 10.75" x 25"	33.5" x 7.25" x 19.75"	48 lbs.	Allen & Heath QU24 Mixer (w/recessed rollers)
BEHRINGER				
FZ3282	42.5" x 8.5" x 26.5"	40" x 6.5" x 21"	46 lbs.	Behringer 3282A mixer
FZBEHX32COM	39.25" x 11.5" x 26.5"	35.5" x 8" x 20.75"	46 lbs.	Behringer X32 mixer console
FZBEHX32DHW	38.75" x 36.5" x 13.5"	39.75" x 32.25" x 14.5"	94 lbs.	Behringer X32 mixer console (w/4 casters)
FZBEHX32W	39.25" x 11.5" x 26.25"	35.5" x 8" x 20.75"	46 lbs.	Behringer X32 mixer case (w/recessed rollers)
FZMX9000CW	40.5" x 12.25" x 41.25"	38" x 10" x 39"	91 lbs.	Behringer MX9000 mixer (w/4 casters)
FZPMH5000	26.25" x 8.75" x 25.75"	23.7" x 6.75" x 22.75"	30 lbs.	Behringer PMH5000 powered mixer/Samson TXM20
FZSL2442	29.5" x 9" x 22"	27.1" x 6" x 19.5"	33 lbs.	Behringer Eurodesk SL2442FX-PRO mixer
MACKIE				
FZCFX12	20.05" x 7.25" x 18"	18.625" x 5" x 12.875"	14 lbs.	Mackie CFX12MKII mixer
FZCFX16	25" x 7" x 18.5"	23.2" x 5" x 16.25"	17 lbs.	Mackie CFX16MKII mixer
FZCFX20	29.25" x 8" x 18.5"	25.625" x 8.5" x 19"	20 lbs.	Mackie CFX20MKII mixer
FZM244	34" x 9.5" x 25"	22.125" x 6" x 31.125"	36 lbs.	Mackie SR24.24 mixer
FZONYX1620	20" x 9.75" x 26.75"	17.6" x 6" x 25.3"	27 lbs.	Mackie ONYX 1620 mixer
FZONYX1640	21" x 10.5" x 30"	18" x 7.8" x 27"	31 lbs.	Mackie ONYX 1640 mixer
FZVLZ3204W	41" x 8.75" x 26.5"	38" x 1.75+4" x 19+3.75"	40 lbs.	Mackie VLZ 3204 mixing console (w/recessed rollers)
MIDAS				
FZMIDM32	39.75" x 14" x 29.75"	34" x 20.25" x 24.25"	53 lbs.	Midas M32 mixer
FZMIDM32DHW	36.75" x 42.5" x 15.5"	34" x 20.25" x 24.25"	114 lbs.	Midas M32 mixer (w/4 casters)



FZGSMX1912
**This case is not designed to transport laptops.*

Flight Zone Series:

MODEL	EXT. DIMS	INT. DIMS	WEIGHT	FITS
PEAVEY				
FZ24FX24	27.25" x 11" x 24"	24.5" x 9.5" x 22"	34 lbs.	Peavey 24FX channel mixer
FZ32FX32	35.25" x 10.5" x 24.5"	33" x 7.5" x 22"	2 lbs.	Peavey 32FX channel mixer (w/recessed rollers)
FZPV14	18.25" x 5.5" x 17.5"	16.3" x 3.5" x 17.5"	12 lbs.	Peavey PV14 mixer
YAMAHA				
FZ02R96W	30.5" x 17" x 35.5"	27.75" x 14.3" x 33.1"	59 lbs.	Yamaha 02R96V2 digital mixer (w/recessed rollers)
FZ5014	20" x 9.25" x 24.5"	17.5" x 6.5" x 22"	26 lbs.	Yamaha EMX5014C/EMX5016CF mixing console
FZEMX500020	28" x 8.75" x 26"	23.8" x 6.5" x 27"	34 lbs.	Yamaha EMX5000 20 channel mixer
FZMG16E	21.5" x 6.75" x 18.25"	18.25" x 4.5" x 16.7"	13 lbs.	Yamaha MG16E/MG16FX
FZMG2414W	34.75" x 8.5" x 27.25"	32.5" x 6" x 24"	43 lbs.	Yamaha MG24/14 FX 14 bus mixer (w/recessed rollers)
FZMG32W	43.5" x 9" x 28"	40.75" x 8" x 25"	49 lbs.	Yamaha MG32/14 FX 14 bus mixer (w/recessed rollers)
FZMGP24XW	35.25" x 9.5" x 28.75"	23.5" x 6.25" x 22.25"	39 lbs.	Yamaha MGP 24X (w/recessed rollers)
FZMGP32XW	43.25" x 9.5" x 28.5"	40.625" x 6.5" x 22.25"	46 lbs.	Yamaha MGP 32X (w/recessed rollers)
FZTF1	22.75" x 12" x 30"	20.25" x 9" x 23.5+3.75"	30 lbs.	Yamaha TF1 Mixing console case
FZTF3W	30" x 11.25" x 31"	28.25" x 9" x 23.5+3.75"	31 lbs.	Yamaha TF3 Mixing console case (w/recessed rollers)
FZTF5W	36.75" x 11.75" x 30"	34.25" x 9" x 23.5+3.75"	50 lbs.	Yamaha TF5 Mixing console case (w/recessed rollers)
UNIVERSAL CASES				
FZ19MIX	21.5" x 10.5" x 20"	19" x 6.5" x 17.5"	24 lbs.	Universal, 19" rackmount mixer up to 10U
FZMX1912	21.5" x 10" x 26.5"	17.5" x 7" x 21"	34 lbs.	Universal, 19" rackmount mixer up to 12U
FZMX1913	28" x 11.25" x 21.25"	28.75" x 12" x 21.75"	34 lbs.	Universal, 19" rackmount mixer up to 13U
FZNR19MIX	21.75" x 10.75" x 23.75"	19.25" x 7.5" x 21"	28 lbs.	Universal, 19" non-rack mount mixer (up to 21" wide)
UNIVERSAL GLIDE STYLE CASES				
FZGS10*	22.25" x 12" x 20"	10U rack space	32 lbs.	Universal, 19" rackmount mixer (w/Glide Platform)
FZGSMX1912*	23" x 11.75" x 26.75"	12U rack space	40 lbs.	Universal, 19" rackmount mixer (w/Glide Platform)
FZGSMX1913*	28.25" x 12.25" x 22"	13U rack space	39 lbs.	Universal, 19" rackmount mixer (w/Glide Platform)

*Glide Style cases are not designed to transport laptops



FZMX1913

Comes with recessed rollers



PAR/LIGHTING/UTILITY CASES

FZPAR2W



Keep your gear looking like new in these versatile utility cases. Carpet lined interior walls make these the perfect storage cases for sound, lighting gear, etc. No more storing your gear in old cardboard boxes.

FZPAR1



FZSLDC1



FZSLDC2W



Recessed rollers for easy transportation on the FZSLDC2W

Flight Zone Series:

MODEL	DIMENSIONS	WEIGHT	FITS
FZPAR1	48" x 20" x 16.5"	50 lbs.	(4) Par 56s with tripod stand and accessories
FZPAR2W	56" x 24.75" x 22.5"	110 lbs.	(8) Par 64s with tripod stand and accessories (features casters)
FZSLDC1	22" x 10" x 22"	20 lbs.	Assorted lighting fixtures or other lightweight gear
FZSLDC2W	31" x 20" x 14"	33 lbs.	Assorted lighting fixtures or other lightweight gear (features rollers)

DUAL MOVING HEAD CASES

Get your moving head lights to where the action is well protected in our sturdy moving head cases. They feature heavy-duty casters, recessed spring-loaded latches, and steel ball corners.

FZMH250SX2W



Fits moving heads by American DJ, Chauvet, Coemar, Elation, Martin, Pearl River, and Robe.

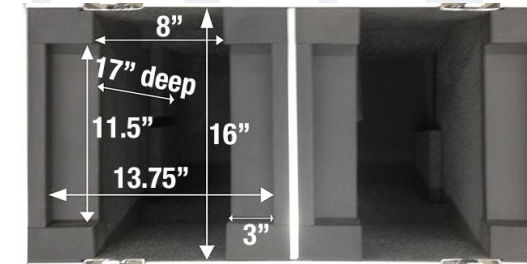

Fits moving heads by Chauvet, Coemar, Elation, Martin, and Robe.

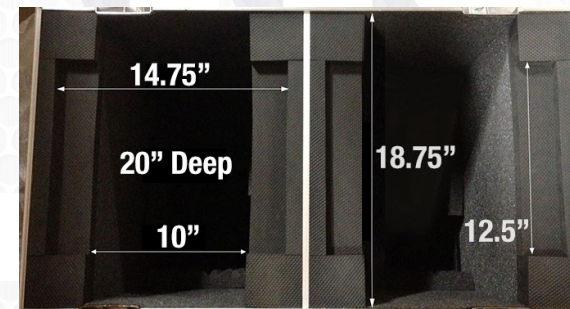

FZMH250X2W



Flight Zone Series:

MODEL	DIMENSIONS	WEIGHT	FITS
FZMH250SX2W	34.25" x 33" x 17.75"	85 lbs.	holds (2) 250 style small moving heads
FZMH250X2W	21" x 35.5" x 36"	100 lbs.	holds (2) 250 style large moving heads
FZCHINT350X2W	32" x 27" x 16.5"	64 lbs.	(2) Chauvet Intimidator Beam/Spot LED 300's/350's, Spot LED 355Z/400 IRC's, and similar size moving head lights."

CHAUVET GEYSER CASE

Make a statement with your Chauvet Geyser RGB protected and stored in an Odyssey FZCHGEYSER vertical fog machine case. With its reverse lid style configuration, just remove the lid, plug in, power up, and then you're all set to go with the Geyser still sitting in the bottom portion of this pro Flight Zone series case. Features include a fully foam-lined interior, heavy-duty recessed handle and latches, and a ventilation/storage pit under the effects fogger.



- Features:**
- Recessed Handle and Latches
 - 3/8" Ply Construction
 - Heavy-Duty Ball Corners
 - Fully Foam-Lined Interior
 - Bottom Ventilation/Storage Pit

Flight Zone Series:

MODEL	DIMENSIONS	WEIGHT	FITS
FZCHGEYSER	22.25" x 11" x 15.25"	19 lbs.	holds Chauvet Geyser RGB Fog Machine

RACK MOUNT LIGHTING CONTROLLER CASES



FRLC04



FRLC08

Flight Ready Series:

MODEL	DIMENSIONS	WEIGHT	FITS
FRLC04	21" x 6.75" x 9"	9 lbs.	Up to 4U Rockmast Light Controllers
FRLC08	21" x 6.75" x 16.25"	13 lbs.	Up to 8U Rockmast Light Controllers

SINGLE FLAT SCREEN MONITOR CASES



FZFSM65W

Keep your flat screen monitor safe in transit with our FZFSM65W ATA case. The interior foam end piece adjusts for width while incremental etha foam strips allow for monitor displays of various thicknesses. The velvet-lined interior foam padding helps keep that clean new monitor look over the long haul and recessed spring-loaded handles all around the sides on both the lid and base ensure proper handling when lifting. Also available for other monitor sizes and in dual monitor case versions.



FZPLASMA50W



FZPLASMA42W

Foam-end piece adjusts for width while incremental etha foam strips allow for various screen thicknesses. Available in 50" and 42" versions.

Flight Zone Series:

MODEL	DIMENSIONS	WEIGHT	FITS
FZFSM65W	68" x 46.25" x 17.75"	148 lbs.	fits one 60" - 65" Flat Screen Monitor
FZPLASMA42W	49.5" x 37" x 15.25"	102 lbs.	fits one 36.5" - 43" Flat Screen Monitor
FZPLASMA50W	62.5" x 44.5" x 16.5"	112 lbs.	fits one 47" - 55" Flat Screen Monitor

DUAL FLAT SCREEN MONITOR CASES

FZ2PLASMA50W

Keep your 50" flat screen monitor safe in transit with our Flight Zone® FZ2PLASMA50W ATA cases that accommodate not one but TWO flat screen monitors. The foam-end pieces adjust for width while incremental etha foam strips allow for various screen thicknesses. Also available for other monitor sizes and in single monitor case versions.

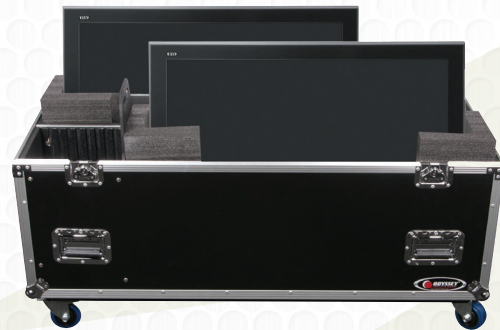

FZ2PLASMA42W

Our flat screen monitor cases can accommodate one or two monitors. Keep yours safe in transit with our single or dual 42", 52 and 65" ATA cases. Foam-end pieces adjust for width while incremental etha foam strips allow for various screen thicknesses.



FZ2FSM65W NEW

Keep your 60-65" flat screen monitors safe in transit with our FZ2FSM65W ATA case. The interior foam end pieces adjust for width while incremental etha foam strips allow for monitor displays of various thicknesses. The velvet-lined interior foam padding helps keep that clean new monitor look over the long haul and recessed spring-loaded handles around the sides on both the lid and base ensure proper handling when lifting. Cases are also available for a single 42", 50", and 65" monitor as well as for dual 42" and 50" monitors.

Flight Zone Series:

MODEL	DIMENSIONS	WEIGHT	FITS
FZ2PLASMA42W	53" x 41" x 22"	150 lbs.	fits two 36" - 43" Flat Screen Monitor
FZ2PLASMA50W	60" x 45" x 22"	175 lbs.	fits two 47" - 55" Flat Screen Monitor
NEW FZ2FSM65W	68" x 44.25" x 17.75"	148 lbs.	fits two 52" - 65" Flat Screen Monitor

StakPak™ SERIES UTILITY TRUNK CASES

Keep all your essential cables and gear safe during transport and organized to boot with our utility StakPak™ cases. All cases feature removable divider, foam-lined interior, piano-hinged lid, recessed latches and handles, and heavy-duty ball corners.



FZUT34422



FZUT32722



FZUT32222



FZUT34417



FZUT34422W

Flight Zone Series:

MODEL	DIMENSIONS	INT. DIMENSIONS	WEIGHT
FZUT32222	22" x 22" x 22"	19.5" x 17" x 19.5"	44 lbs.
FZUT32722	27" x 18" x 22"	24.5" x 13" x 19.5"	44 lbs.
FZUT34417	44" x 19" x 17"	41.5" x 13" x 14.5"	52 lbs.
FZUT34422	44" x 23" x 22"	41.5" x 17" x 19.5"	71 lbs.
FZUT34422W	44" x 27" x 22"	41.5" x 17" x 19.5"	91 lbs.

UTILITY TRUNK TRUCK PACK CASES

Truck Packs are able to store and transport all that extra gear you need on tour. Each comes standard with recessed hardware and carpet lined interior.



FZTP020W

Flight Zone Series

MODEL FZTP090W
DESCRIPTION Our 3 piece Truck Packs can hold a wide variety of gear. Bottom pack has caster wheels.

Ext. Dims: (2) Top 21" x 18" x 16"
 (1) Bottom 32" x 22.5" x 21"

Use these truck packs for a fast and efficient use of space. They're great for easy loading in and out of venues. Each features recessed hardware, spring-loaded handles and include 3 inch casters, two of which have super stop brakes.

Flight Ready Series:

MODEL	DIMENSIONS	INT. DIMENSIONS	WEIGHT
FRTP020W	22" x 29.34" x 22"	20" x 20" x 20"	46 lbs.

UTILITY TRUNK CASES

These big boys can hold a ton of gear and keep it all organized to boot! Both cases feature 3.5" heavy-duty casters, 2 with brakes, and can hold gear up to 42" x 27" x 23" deep (26" from floor to top lid). The FZUT2W comes well-equipped with 7 dividers (2 tall, and 5 flush) with one small and one large tray that sits on top of the flush dividers. Use any combination of trays and dividers to keep all your gear safe during transport. The FZUT2W-EMPTY version comes without trays and dividers.



Removable dividers



FZUT2W

Made to truck pack dims!



FZUT2W-EMPTY



Flight Zone Series:

MODEL	DIMENSIONS	INT. DIMENSIONS	WEIGHT
FZUT2W	44.75" x 31" x 29.5"	42" x 23" x 27" (includes trays and dividers)	166 lbs.
FZUT2W-EMPTY	44.75" x 31" x 29.5"	42" x 23" x 27"	120 lbs.

PLUCK FOAM UTILITY CASES

FZWIRELESS

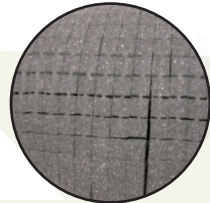

Pre-cut diced foam

FZLUC



FZUC



Protect your valuable digital recorders, samplers, drum machines, controllers and other tabletop gear with our Utility Carrying Cases. These cases come with pre-cut, diced foam so it's easy to make the foam interior match the shape of just about anything you put inside! The FZUC (small Utility Case) and FZWIRELESS (Wireless System Case) cases come with a lockable luggage type clasp and non-removable hinged lid that stays open and upright by itself. The larger FZLUC (Large Utility Case) and FZDRC (Digital Recorder Case) feature heavy-duty butterfly latches with padlock slots and removable hinged lids.

Flight Zone Series:

MODEL	DIMENSIONS	WEIGHT
FZUC	15" x 6.5" x 13"	5 lbs.
FZDRC	24.75" x 10" x 20.375"	19 lbs.
FZLUC	23.5" x 6.75" x 11.75"	9 lbs.
FZWIRELESS	19" x 4.75" x 18"	11 lbs.

D.I.Y. Diced Foam:



Trace your gear on a sheet of paper



Cut out the pattern. Cut inside the lines for a tighter fit.



Put pattern in desired position and pull foam apart



Test fit and pull more foam as needed

FZDRC



NEED CUSTOM U.S. MADE CASES? WE'RE YOUR ANSWER!



ODYSSEY CADILLAC ROAD CASES

Our industry standard road case AKA "Cadillac" are made to carry heavy loads. Truck pack sized cases, recessed hardware birch ply walls, painted or optional Line-X Tuff Kote™ exterior coating, stack ability and heavy weight casters are what we do. Every gig is different, we also offer heavy duty removable dividers for your cases to be as flexible as the work you do. Added Muscle includes 2" x 4" super duty casters that feel like the case is cruising on its own! Our design specialists will work with you to meet the challenges you face everyday.



ODYSSEY LIGHTING CASES

You're different. You have unique challenges. Your combination of lighting gear is complicated. Your load in just takes too long... Let us work with you to create an engineered case system that will travel in your vehicles, roll into your venues, and store in your shop all with the right footprint. Storage space is \$\$\$, we get it. At BC Cases, you know we use the right stuff to build cases that last. Add some "smart muscle" to your business and let us work with you to design the lighting cases that will get your job done, on time, no matter where it is!



Our custom cases are built in Los Angeles, California, USA. This gives us the unique ability to work directly with manufacturers to build the strongest and best fitting cases in the industry. Whether the lights you choose are built in the USA or elsewhere, they come through L.A. and our design specialists are here to design the best protection for your prcucious investment!



MOTOR CASES

All of the "Rock Solid" features that have made our ATA Trunks a top seller for over 45 years go into our Motor and Chain Hoist cases. Recessed hardware, multi-ply walls, stack-ability and heavyweight casters. BC Cases are made here in the USA with proven designs and technology. Our design specialists work with the manufacturers to ensure a proper fit. It takes Powerful Stuff to load in a light show, and BC Cases is all in for the life of your gear.

ODYSSEY WORKBOXES

Years ago, the workboxes we designed were used primarily for military applications. They needed to withstand the harshest of conditions and impossible obstacles. They've stood the test of time for over 45 years! In the case industry, design means everything. We use the best drawer glides, table legs & latching hardware and casters.

We'll work with you to ensure that what we build is precisely what you need, and more!



ODYSSEY DRAWER CASES

When your gear is on the road, organization is critical to eliminating loss, and keeping work time to a minimum. There isn't time to dig through piles and large spaces to find things that costs you money.

Let us create specific foam drawer inserts that remind you "Hey! Where's the widget that goes here, did you forget?" Ask us about our custom silk screening and stenciling features. Don't forget we can match your company "look" with custom colors and printed silkscreen logos.



CUSTOM FOAM INSERTS

We also specialize in custom fitting your foam inserts to fit your products perfect and precise, keeping your important equipment safely shielded and protected.

Mic Inserts, Foam Inserts, Single, Dual all available upon custom build request. Give us a call for more information.



Our polymer plastic water-tight, dust proof and impact resistant injection molded cases are made of a high strength polymer resin which will provide the ultimate in protection for your gear. Each case features a diced foam interior that can be plucked to the shape of the gear or have a custom foam LASER cut-out. Standard features include a comfortable carrying handle, pressure release valve and padlock loops.

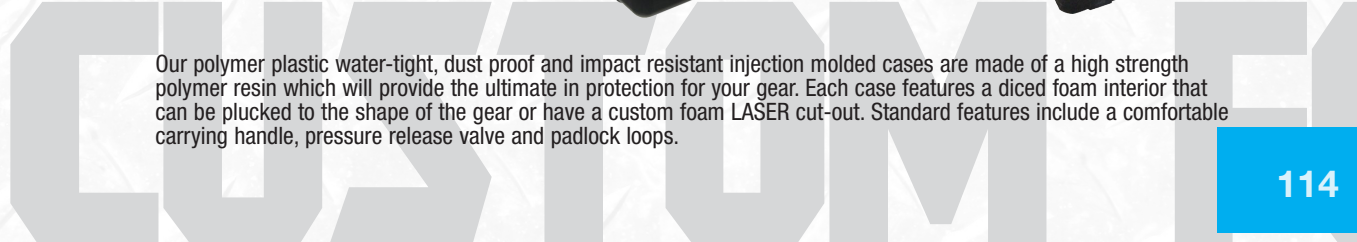

UTILITY CARRYING CASES



Watertight seal



Pressure release valve

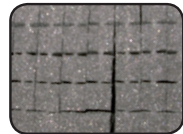

Easy to shape pluck foam included

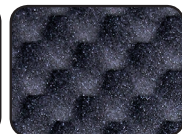

Soft, egg crate foam lid lining



VUXS

VUS

VUM

VUL

Our polymer plastic water-tight, dust-proof and impact resistant injection molded cases are made of a high strength polymer resin which will provide the ultimate in protection for your gear. Each case features a diced foam interior that can be plucked to the shape of the gear you are storing inside. Standard features include a comfortable carrying handle, pressure release valve and padlock loops.

MODEL	DIMENSIONS	INT. DIMENSIONS	*BASE HEIGHT	WEIGHT
VUXS	8.5" x 3.5" x 7.25"	7" x 2.75" x 4.625"	2.5"	2 lbs.
VUXS2	9.25" x 2.5" x 5.25"	8.25" x 2" x 4.25"	2.5"	1 lbs.
VUS	13" x 5" x 11.125"	11.5" x 4" x 8.25"	3"	5 lbs.
VUM	17" x 6.25" x 15.125"	15.25" x 5.25" x 12"	4.5"	8 lbs.
VUL	20.5" x 7.825" x 16.5"	18.25" x 7" x 13.5"	4"	9 lbs.



VU160910S **NEW**

This "S" model design features a shoulder strap for convenient transport.



VUS2 **NEW**



MODEL	DIMENSIONS	IN. DIMENSIONS	WEIGHT
NEW VU160910S	16.5" x 11" x 11"	16" x 9.5" x 9"	7 lbs.
NEW VUS2	11.75" x 8" x 9.5"	9.25" x 7.25" x 7.25"	4 lbs.

MIXED/PLAYER CARRYING CASES

TROLLEY UTILITY CASES

VRANE62



VUDJMS9

NEW



VUX1800

NEW



VUCDJ2000XS2

NEW



VUSC5000

NEW



VUDJM900XS2

NEW



MODEL	DIMENSIONS	FITS	WEIGHT
NEW VRANE62	20.5" x 7.75" x 16.5"	fits the Rane 62 mixer	9 lbs.
NEW VUCDJ2000XS2	20.5" x 7.75" x 16.5"	fits the Pioneer CDJ-2000XS2	9 lbs.
NEW VUDJMS9	20.5" x 7.75" x 16.5"	fits the Pioneer DJM-S9 mixer	9 lbs.
NEW VUDJM900XS2	20.5" x 7.75" x 16.5"	fits the Pioneer DJM-900XS2	9 lbs.
NEW VUSC5000	20.5" x 7.75" x 16.5"	fits the Denon SC5000	9 lbs.
NEW VUX1800	20.5" x 7.75" x 16.5"	fits the Denon X1800	9 lbs.

NEW

VU200911HW



Watertight seal



Pressure release valve

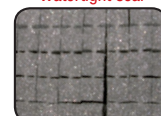

Easy to shape pluck foam included



Soft, egg crate foam lid lining



*Base Height

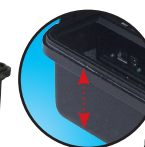

VU170714HW



MODEL	DIMENSIONS	INT. DIMENSIONS	*BASE HEIGHT	WEIGHT
NEW VU170714HW	18.5" x 9" x 15.5"	17" x 7" x 14"	5"	11 lbs.
VU200711HW	22" x 9" x 14"	20" x 7" x 11.5"	5"	11 lbs.
VU221411HW	15.5" x 24.25" x 13.5"	14" x 22.75" x 11.75"	9.8"	16 lbs.
NEW VU200911HW	22 x 11.5 x 13.5	20 x 9.5 x 11.5		14 lbs.

UTILITY CARRYING CASES WITH RECESSED CORNER WHEELS



VU420514W



Soft, egg crate foam lid lining

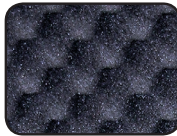

Soft, egg crate foam lid lining

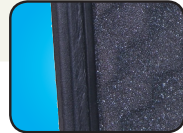

Watertight seal



Pressure release valve



VU500513W



MODEL	DIMENSIONS	IN. DIMENSIONS	WEIGHT
VU420514W	44.5" X 6.5" X 14.5"	42" X 5.5" X 14.5"	20 lbs.
VU500513W	52" X 6.25" X 15.5"	50" X 5.5" X 13"	23 lbs.



VU350514W **NEW**



Soft, egg crate foam lid lining



Soft, egg crate foam lid lining



Watertight seal



Pressure release valve

MODEL	DIMENSIONS	IN. DIMENSIONS	WEIGHT
VU350514W	38.5" x 6.75" x 17"	35.75" x 5.25" x 14.5"	18 lbs.

PRODUCT GUIDE

CD/DIGITAL MEDIA & TURNTABLE DJ COFFINS - CARPETED

CARPET GLIDE STYLE™ CD/DIGITAL MEDIA DJ COFFINS LARGE FORMAT



CGS10CDJ



Large format CD/Digital DJ Coffins fit players such as:
Denon SC5000 PRIME
Gemini CDJ-700, MDJ-1000
Pioneer CDJ-850/900NXS/2000NXS2, XDJ-1000MK2
Reloop RMP-4



MODEL	DIMENSIONS	WEIGHT	FITS
CGS10CDJ	44.5" x 9.5" x 22"	38 lbs.	10" format mixer, (2) large format CD/Digital Media Players
CGS12CDJ	48" x 9.5" x 20.25"	40 lbs.	12" format mixer, (2) large format CD/Digital Media Players

*These cases are not designed to transport laptops.

CARPET GLIDE STYLE™ TURNTABLE BATTLE DJ COFFINS



CGSBM10

Holds Pioneer, Numark, Stanton, as well as Technics 1200 style turntables!

MODEL	DIMENSIONS	WEIGHT	FITS
CGSBM10	47.5" x 9.25" x 21.25"	52 lbs.	10" format mixer, (2) 1200 style turntables in battle mode
CGSBM12	52" x 9.25" x 21.5"	54 lbs.	12" format mixer, (2) 1200 style turntables in battle mode

*These cases are not designed to transport laptops.

TURNTABLE CASES & DJ COFFINS - CARPETED TURNTABLE CASES/DJ COFFINS



TURNTABLE CASES

Our pro carpeted single turntable case is made of a long lasting durable carpet finish and comes standard with steel recessed hardware including stackable ball corners. Standard model is also available with surface mount hardware.

MODEL	DIMENSIONS	WEIGHT	FITS
CTTE (Standard)	22.5" x 8.5" x 17"	20 lbs.	1200 style turntable
CTTP (Pro)	22.5" x 8.5" x 17"	18 lbs.	1200 style turntable

CTTP Pro
Pro Version



TURNTABLE DJ COFFINS STANDARD MODE

Our mixer carpet-covered DJ coffins are made to last regardless of which model you choose. Standard "E" models have surface mount hardware. The "P" version has all the bells and whistles, with fully foam-lined turntable wells and recessed hardware.

CDJ10 Pro Version



CDJ19P Pro Version



MODEL	DIMENSIONS	WEIGHT	FITS
CDJ10E (STANDARD)	52" X 7" X 18.5"	42 LBS.	10" STYLE MIXER, (2) 1200 STYLE TURNTABLES (ACTUAL MIXER WELL IS ONLY 9.25" IN WIDTH)
CDJ10 (PRO)	52" X 7" X 18.5"	47 LBS.	10" STYLE MIXER, (2) 1200 STYLE TURNTABLES (ACTUAL MIXER WELL IS ONLY 9.25" IN WIDTH)
CDJ19E (STANDARD)	57" X 8" X 16"	48 LBS.	19" MIXER, (2) 1200 STYLE TURNTABLES
CDJ19P (PRO)	63" X 8.5" X 18"	50 LBS.	19" MIXER, (2) 1200 STYLE TURNTABLES

TURNTABLE DJ COFFINS BATTLE STYLE

Our carpeted Battle Style Coffin for 10" mixers feature turntables in the preferred sideways position for scratch DJs. Also great for vinyl DJs who want a smaller coffin. Available in Pro and Standard Versions.

MODEL	DIMENSIONS	WEIGHT	FITS
CBM10E (STANDARD)	57" X 7.5" X 21.5"	42 LBS.	10" STYLE MIXER, (2) 1200 STYLE TURNTABLES (ACTUAL MIXER WELL IS ONLY 9.25" IN WIDTH)
CBM10 (PRO)	57" X 7.5" X 21.5"	47 LBS.	10" STYLE MIXER, (2) 1200 STYLE TURNTABLES (ACTUAL MIXER WELL IS ONLY 9.25" IN WIDTH)

CBM10 Pro Version

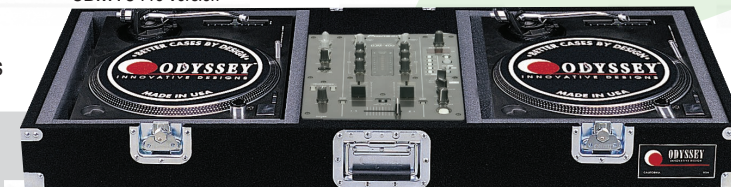

CARPET STANDARD SERIES AMP RACKS



CRE12W



CRE08



CRE08

Our CRE series racks are super durable, featuring all plywood construction, metal hardware, heavy-duty pretapped rack rails, recessed large grip handles, friction fit front and rear lids and large rubber feet or 3" caster wheels.

MODEL	SPACE	DIMENSIONS	INT. DEPTH	WEIGHT	HANDLES	3" CASTERS
CRE02	2U	21" x 6" x 20"	17"	23 lbs	1	no
CRE04	4U	21" x 9.5" x 20"	17"	26 lbs	1	no
CRE06	6U	21" x 13" x 20"	17"	30 lbs	2	no
CRE08	8U	21" x 16.5" x 20"	17"	33 lbs	2	no
CRE10	10U	21" x 20" x 20"	17"	38 lbs	2	no
CRE12	12U	21" x 25.5" x 20"	17"	45 lbs	2	no
CRE12W	12U	21" x 28.5" x 20"	17"	53 lbs	2	yes
CRE14	14U	21" x 28.5" x 20"	17"	50 lbs	2	no
CRE14W	14U	21" x 32" x 20"	17"	58 lbs	2	yes
CRE16	16U	21" x 32" x 20"	17"	55 lbs	2	no
CRE16W	16U	21" x 35.5" x 20"	17"	63 lbs	2	yes
CRP18	18U	21" x 35.5" x 20"	17"	60 lbs	2	no
CRP18W	18U	21" x 39.75" x 20"	17"	68 lbs	2	yes

"W" versions include wheels for easy transportation

CARPET PRO SERIES AMP RACKS



CRP16W



Edgeguard™ PROTECTED



CRP08W



Edgeguard™ PROTECTED

CRP04



Edgeguard™ PROTECTED

Our CRP series racks feature all plywood construction, metal hardware, heavy-duty pre-tapped rack rails, recessed large grip handles, recessed flush mount lids with latches, and large heavy-duty steel corners. The "W" models include 3" super strong caster wheels and pre-installed T-nut fasteners.

MODEL	SPACE	DIMENSIONS	INT. DEPTH	WEIGHT	HANDLES	3" CASTERS
CRP02	2U	21" x 7.5" x 22"	18.5"	29 lbs.	2	no
CRP04	4U	21" x 10.5" x 22"	18.5"	33 lbs.	2	no
CRP06	6U	21" x 14" x 22"	18.5"	38 lbs.	2	no
CRP08	8U	21" x 17.5" x 22"	18.5"	42 lbs.	2	no
CRP08W	8U	21" x 21.5" x 22"	18.5"	46 lbs.	2	yes
CRP10	10U	21" x 21" x 22"	18.5"	47 lbs.	2	no
CRP10W	10U	21" x 25" x 22"	18.5"	55 lbs.	2	yes
CRP12	12U	21" x 25.5" x 22"	18.5"	52 lbs.	4	no
CRP12W	12U	21" x 29.5" x 22"	18.5"	60 lbs.	4	yes
CRP14W	14U	21" x 32.5" x 22"	18.5"	65 lbs.	4	yes
CRP16W	16U	21" x 36.5" x 22"	18.5"	70 lbs.	4	yes
CRP18	18U	21" x 36" x 22"	18.5"	78 lbs.	4	no
CRP18W	18U	21" x 40" x 22"	18.5"	86 lbs.	4	yes

"W" versions include wheels for easy transportation

CARPET PRO SERIES COMBO RACKS



Available in 5 sizes, these cases feature an angled, protruding top section and a flush mount angle on the PRO133 and PRO136. Pro series cases feature removable top and front covers, removable rear access panel for easy cable hook ups, and recessed Black hardware.

PRO103



PRO106



MODEL	DIMENSIONS	WEIGHT	SLANTED	VERTICAL
PRO103	21.5" x 17.25" x 20"	42 lbs.	10U	3U
PRO106	21.5" x 22.50" x 20"	52 lbs.	10U	6U
PRO108	21.5" x 26" x 20"	55 lbs.	10U	8U
PRO133	21.5" x 23" x 24"	50 lbs.	13U	3U
PRO136	21.5" x 27" x 24"	60 lbs.	13U	6U

CARPET CXC SERIES COMBO RACKS



The CXC Combo series features a flush mount slanted top section. Unique to Odyssey cases, the removable front & back access panels are interchangeable. Just one less thing to worry about for a quick break down of equipment after a gig.



SURFACE MOUNT LATCHES



HEAVY-DUTY HANDLES



CXC902



CXC1016W

MODEL	DIMENSIONS	WEIGHT	SLANTED	VERTICAL
CXC902	21.5" x 15.5" x 20"	37 lbs.	9U	2U
CXC904	21.5" x 19" x 20"	42 lbs.	9U	4U
CXC906	21.5" x 22" x 20"	47 lbs.	9U	6U
CXC908	21.5" x 26" x 20"	50 lbs.	9U	8U
CXC1016W	21.5" x 42" x 20"	78 lbs.	10U	16U

"W" version includes wheels for easy transportation

CARPET CXP SERIES COMBO RACKS



THE MOST POPULAR COMBO RACK PREFERRED BY AUDIO PROFESSIONALS!

FEATURES:

- Angled protruding top
- Slanted top - 11 space standard
- Recessed Steel Latches & Handle
- Pretapped steel rack rails
- Edge Guard™ front and rear
- 3" heavy-duty caster wheels
- 3/4" multi-layer AA grade premium plywood
- Interchangeable front & back panels
- Add optional rear rack rails for added gear support.



CXP1118W

Edgeguard™ PROTECTED



CXP1112W

Edgeguard™ PROTECTED



Our combo racks hold a variety of components up to 18 spaces! They come equipped with recessed soft grip spring-loaded handles and heavy-duty 3" caster wheels for comfortable transport from gig to gig. The front and rear patented Edgeguard prevents direct impact to your case. Optional cam-locks can be requested for your case to secure and deter theft and damage to all your valuable rackable components.

MODEL	DIMENSIONS	INT DEPTH	WEIGHT	SLANT	VERTICAL	CASTERS
CXP1102	22" x 16.5" x 22"	18.5"	42 lbs.	11U	2U	NO
CXP1104	22" x 20" x 22"	18.5"	47 lbs.	11U	4U	NO
CXP1106	22" x 23" x 22"	18.5"	52 lbs.	11U	6U	NO
CXP1108	22" x 27" x 22"	18.5"	57 lbs.	11U	8U	NO
CXP1108W	22" x 31" x 22"	18.5"	65 lbs.	11U	8U	YES
CXP1110	22" x 30.5" x 22"	18.5"	62 lbs.	11U	10U	NO
CXP1110W	22" x 34.5" x 22"	18.5"	70 lbs.	11U	10U	YES
CXP1112	22" x 34" x 22"	18.5"	67 lbs.	11U	12U	NO
CXP1112W	22" x 38" x 22"	18.5"	75 lbs.	11U	12U	YES
CXP1114W	22" x 41.75" x 22"	18.5"	82 lbs.	11U	14U	YES
CXP1116W	22" x 45.25" x 22"	18.5"	88 lbs.	11U	16U	YES
CXP1118W	22" x 49" x 22"	18.5"	95 lbs.	11U	18U	YES

"W" versions include wheels for easy transportation

CARPET CXG SERIES COMBO RACKS



CXG902
Edgeguard™ PROTECTED



CXG908
Edgeguard™ PROTECTED

COMBO ON THE GO!
Essential Dimensions

- Top (Mixer Section) 9 spaces
- Bottom (Rack Section): available in 2, 4, 6, or 8 spaces
- Internal Depth: (Rack Section) 17"

MODEL	DIMENSIONS	WEIGHT	VERTICAL
CXG902	21.5" X 12.5" X 20"	32 lbs.	2U
CXG904	21.5" x 16.0" x 20"	35 lbs.	4U
CXG906	21.5" x 19.5" x 20"	40 lbs.	6U
CXG908	21.5" x 23.0" x 20"	44 lbs.	8U

CARPET SLIDE STYLE™ COMBO RACKS



Our patented Slide Style cases are thoughtfully designed and solidly built. Functional yet unobtrusive, they're practical for all DJs needing horizontal access to their gear. Essential in protecting your racked gear, like drive bays, EQs or other control panels above the mixer section. Features solid aluminum rails to slide the top rack back for easier access to controls on your mixer or other gear.



CS4812W
Edgeguard™ PROTECTED

Patented Slide Style

MODEL	DIMENSIONS	INT DEPTH	WEIGHT	TOP	SLANTED	BOTTOM	HANDLES	EDGE GUARD
CS4800	21" x 15" x 17.5"	18.5"	36 lbs.	4U	8U	N/A	2	No
CS4812W	22" x 45" x 22"	18.5"	97 lbs.	4U	8U	12U	4	Yes
CS4814W	22" x 48.5" x 22"	18.5"	104 lbs.	4U	8U	14U	4	Yes

"W" versions include caster wheels for easy transportation

CARPET LAPTOP SLIDE STYLE™ COMBO RACKS



CSL28
Slide Style™

Our laptop Slide Style™ racks are made to hold a total of 8 spaces at the mixer slant and 2 spaces that slide back up above and your laptop right above it all. This patented design makes the life of the laptop digital DJ that much more efficient. Made with all recessed hardware and spring-loaded handles.



CSL2802
Slide Style™

Patented Slide Style

CSL2802



Setting up for gigs is even easier with our CSL2802. Just connect your laptop and you are ready to go!

MODEL	DIMENSIONS	WEIGHT	SPACE
CSL28	22" X 18" X 22"	48 lbs.	2U+8U
CSL2802	22" x 21" x 22"	51 lbs.	2U+8U+2U

PRODUCT GUIDE

STUDIO RACKS AND TOURING CASE- CARPETED

CARPET STUDIO RACKS



Our carpeted studio racks keep your studio tidy and looking good at the same time. They feature 3/4" multi-layered plywood construction and an angled face for easy viewing of all your gear, top to bottom. Completely open back; no front or rear covers.



CRS14W



CRS08



2" or 3" Castor Wheels on "W" models

CRS20W



MODEL	SPACE	WIDTH	HEIGHT	DEPTH AT TOP SPACE	DEPTH AT BOTTOM SPACE	WEIGHT	CASTERS
CRS08	8U	21"	19"	12"	16"	28 lbs.	no
CRS12	12U	21"	25"	13"	16"	36 lbs.	no
CRS14W	14U	21"	33"	16"	22"	50 lbs.	2"
CRS20W	20U	21"	42.5"	16"	22"	56 lbs.	2"
CRS24W	24U	21"	50"	16"	22"	65 lbs.	3"
CRS30W	30U	21"	60"	16"	22"	72 lbs.	3"

CARPET TRUCK PACK UTILITY TOURING CASE



Use the CTP020W truck pack utility touring case for a fast and efficient use of space. Its great for easy loading in and out of venues. Features include recessed hardware, spring-loaded handles, and include 3 inch casters, two of which have super stop brakes.

MODEL	DIMENSIONS	WEIGHT	CASTERS
NEW CTP020W	20.75x20x20.7	49 lbs.	3"



NEW CTP020W

CD/ 5" MEDIA DISC CASES DISC CASES - CARPETED

CARPET CD/5" MEDIA DISC CASES



CCD300E
Standard Version



CCD450E
Standard Version



CCD320PW
PRO Version

Pro Series:

MODEL	DIMENSIONS	WEIGHT	FITS*
CCD300P	24.5" x 7" x 12.75"	17 lbs.	300 view packs or 100 Jewel Cases
CCD320PW	46" x 8" x 18.5"	40 lbs.	960 view packs or 320 Jewel Cases
CCD450P	24.5" x 7" x 17"	22 lbs.	450 view packs or 150 Jewel Cases

Standard Series:

MODEL	DIMENSIONS	WEIGHT	FITS*
CCD225E	19" x 7" x 12.5"	13 lbs.	225 view packs or 75 Jewel Cases
CCD300E	24.5" x 7.25" x 12.75"	15 lbs.	300 view packs or 100 Jewel Cases
CCD450E	24.5" x 7.25" x 17"	20 lbs.	450 view packs or 150 Jewel Cases

*Jewel case quantity is approximate and will depend on the size of the jewel cases.

KROM™ CASES - BLACK KROM™ SERIES

BLACK KROM™

Our Black KROM™ series cases are designed for the DJ who wants something that looks super slick and doesn't really need a flight case to travel with his gear. Great for light-duty use, this series is built with all black powder coated hardware, stealth black laminate, and steel corners that are uniquely hexagon-shaped. The DJ mixer and CD/media player carrying cases have a fully foamed-lined interior with a velvet-lined bottom which includes an open pit under the gear that allows for ventilation and storage space for cables and other essentials. The interiors of the universal DJ controller cases are fully carpeted as well as foamed-lined ensuring secure transport for a diverse variety of today's popular DJ controllers. Each of the controller cases also include lift out trays to place your gear on inside as well as outside your case.

K10MIXBL



K1200BL



KDJC2BL



K12MIXCDJBL



MODEL	DIMENSIONS	WEIGHT	HOLDS
K10MIXBL	14" x 7.75" x 20.25"	10 lbs.	10" Format mixers up to 10.75" Wide
K1200BL	20" x 7.25" x 17.75"	10 lbs.	1200 Style Turntables
K12MIXCDJBL	16" x 7.75" x 20.25"	11 lbs.	12" Format mixers up to 13" Wide & Large Format CD/Media Players
KDJC1BL	18.2" x 7.25" x 17.5"	10 lbs.	Extra Small DJ Controllers up to 15.75"W x 3.5"H x 13.5"D
KDJC2BL	21.5" x 7.25" x 18.5"	13 lbs.	Small Size DJ Controllers up to 19.75"W x 4"H x 13.5"D
KDJC3BL	25.5" x 7.25" x 18.25"	15 lbs.	Medium Size DJ Controllers up to 23.75"W x 3"H x 13.5"D

KROM™ CASES - BLACK KROM™ SERIES



- K45060BL**
- detachable lid
 - foam-lined, holds approx. 60 7" vinyl records
 - Includes adjustable interior divider
 - 8.75" x 9.5" x 9.25", 5 lbs.



- K45120BL**
- detachable lid
 - foam-lined, 2-row interior, holds approx. 120 7" vinyl records
 - adjustable divider
 - 16.75" x 9.25" x 9.25", 7 lbs.

- KLP70BL**
- detachable lid
 - foam-lined, holds approx. 70 12"/LP vinyl records
 - 14.75" x 14.5" x 11", 5 lbs.



- KUH9BL**
- foam-lined, 2 row interior, holds headphone & accessories
 - adjustable dividers
 - 12" x 6.5" x 9.225", 4 lbs.



Set up of three K12MIXCDJBL cases

KROM™ CD/5" MEDIA DISC DISC CASES



- KCD300 DIA**
- detachable lid
 - foam-lined, 3-row interior holds approx. 300 CDs in viewpacks or 100 CDs in jewel cases*
 - 18" x 6.5" x 13", 12 lbs.



- KCD600W**
- detachable lid
 - foam-lined, 4-row interior holds approx. 600 CDs in viewpacks or 200 CDs in jewel cases*
 - 24.5" x 8" x 24.5", 17 lbs.

KROM CD/5" MEDIA DISC DISC CASES



- KCD200 DIA**
- detachable lid
 - holds approx. 200 CDs in viewpacks or 65 CDs in jewel cases*
 - foam-lined, 3-row interior
 - 18" x 9" x 11", 9 lbs.



lockable latches deter unwanted access



*Jewel case quantity is approximate and will depend on the size of the jewel cases.

KROM™ VINYL RECORD/UTILITY CASES

Protect your rare and hard to find records for your special 45 rpm vinyl DJ sets or just for safe keeping in our Krom™ series K45120 utility/record cases. Each has two individual compartments that hold a total of 120 7" vinyl records, 60 in each section, and can also be used as a utility case for cables, scrims, and other gig essentials. Features include chrome plated hardware, a removable lid, a fully foam-lined interior a heavy-duty latch and spring-loaded handle. Individual K45120 cases can be stacked on each other for convenient storage.



- Features:**
- Heavy-Duty Butterfly Latch and Spring-loaded Handle
 - Pad Lock Latch Holes
 - Holds 120 7" Vinyl Records, 60 Per Compartment
 - Bottom compartments are 8" x 8" x 5"
 - Interior Lid Height is 2.5"
 - Foam-lined Interior
 - Rubber Feet
 - Stacking lid
 - Exterior Dim 17.25" x 9.75" x 9.25"
 - Weight 6 lbs.

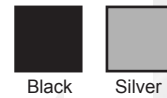

K45120

The KLP1 holds 70 LPs in its foam-lined interior compartment, comes in black or silver, and features a removable lid with a lockable butterfly latch.



- KLP1**
- detachable lid
 - holds approx. 70 LPs
 - 14" x 14" x 11", 10 lbs.
 - 20/80 Split Lid

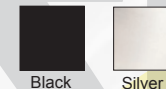

- KLP2**
- stackable cases
 - detachable lid
 - holds approx. 70 LPs
 - 14" x 14" x 11", 10 lbs.
 - 20/80 Split Lid

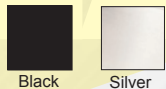

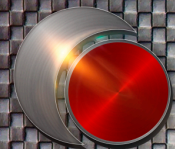

ODYSSEY®

LEADING THROUGH INNOVATION

HOT! DJ CASES FOR TODAY'S HOTTEST DJ GEAR

BRLDIGITAL3XL



The Redline™ Digital 3XL bag lets you take a wide variety of your essential gear for your digital set up from one gig to the next. The main compartment includes foam inserts that can easily be adjusted to safely store the popular Pioneer DDJ-RZ, DDJ-SZ, MCX8000, XDJ-RX or other similar sized gear while in the second section store 2 laptops side by side or an accessory of comparable size (such as our LSTAND360 folding laptop stand). There's even a smaller dedicated pocket for tablets. The front compartment includes cable straps and padded pockets that can be used for smaller more compact gear such as hard drives, power adapters, and microphones.



REDLINE™ SERIES BAGS

DIGITAL GEAR BACKPACKS

REDLINE™
SERIES

When you're on the go take your essential DJ gear with you in an Odyssey's Redline™ Series DJ backpack. Multiple Padded compartments and pockets easily store your Serato or Traktor vinyl and interface, laptop, compact DJ controllers, microphones, cables, hard drives, headphones, and much more. Each is padded in and out in all the right places for ultra comfort during your daily DJ activities and for ultimate mobile protection of your DJ gear.



BRLBACKSPIN2

Features and specs:

- Fully Padded Interior Compartments for Gear Protection
- Multiple Pouches and Pockets for Organized Packing
- Dedicated Padded Compartment for Laptop
- Meets Most Airline's Carry-on Size Requirements
- Heavy-Duty Zippers and Zipper Pulls
- Convenient Elastic Band Cable Holders
- Easy Accessible Large Side and Front Pockets
- Padded Back and Shoulder Straps for Extra Comfort

Dimensions (exterior):
16"W x 19"H x 10"D
Weight 4 lbs.



BRLRMXBP1

MOBILE TRIPOD SYSTEM WHEELED TOTE BAG

Features and specs:

- Interior Straps for Securing Gear
- Heavy-Duty Zippers and Zipper Pulls
- Top Interior, Easy-Accessible Transparent Pouch
- Large Side and Small Front Pocket Compartments
- Sturdy Rear Wheel Frame, Exterior Straps, and Front Handle For Convenient Hauling
- Exterior Dimensions (Folded with empty interior): 24" x 16" x 17.5"
- Interior Dimensions: 65" x 9" x 11"
- Can Handle Loads Up To 100 lbs.

Fits Mobile Tripod Systems such as:

- Odyssey LTMTS1-PRO 10' crank up truss system
- Odyssey LTMTS3 10' truss system with T-bars
- Odyssey LTMVSS1014L Video Screen System and more!



BRLTMTSW

REDLINE™ SERIES PAR LIGHTING/GEAR BAG

From the Odyssey Redline™ Series family comes the BRLPAR1HW, a uniquely diverse trolley style DJ gig bag that every active mobile DJ will ache for. It's specially designed to making it that much easier to transport your par uplights or other gear along with cables and related essentials efficiently, securely, and conveniently organized. Included are uniform adjustable dividers that can be arranged to as many as 16 individual padded compartments. Just configure the interior as you required and take what is needed. Get the BRLPAR1HW and be up to PAR for your next event whether it's an elegant banquet or straight up house PAR-ty!

- Features:
- 3" Wheels
 - 2.5" Heavy-Duty Buckles
 - Pullout Handle Extends 12.25"
 - Adjustable Dividers can be Configured to a Maximum 16 Interior Compartments
 - Interior Dimensions Without Dividers: 29" x 16" x 10.5"
 - Transparent Exterior Pocket Dimension: 6" x 4.5"
 - Side Pocket Dimension: 21.5" x 9"

UTILITY/SHUTTLE BAG



BRLUT1HW

This Odyssey trolley utility bag is designed to make it that much easier to transport various gear essentials efficiently, securely, and conveniently. Included are adjustable dividers that can be arranged to divide the main interior into two sections. Just configure the interior as you require and take what is needed for your photo booth or DJ setup.

- Features:
- Interior Foam Padding all Around
 - 2" Dual Trolley Wheels
 - Includes 3 Adjustable Dividers for Various Dual Compartment Configurations
 - Interior Dimensions Without Dividers: 21" x 16" x 12"
 - Exterior Pocket Dimensions: each is 16" x 10" x 1.25"
 - Upright Dimensions: 17"W x 26-39.75"H x 16"D
 - Pullout Handle Extends 14.5"

BRLPAR1HW



Dims (Exterior): 31.5"W x 15"H x 8.5"D
Weight: 14 lbs

REDLINE™ SERIES

BRLSPKSM

Fits many 12" molded speakers



Dimensions:
(exterior): 27"W x 15"H x 17.25"D
(interior): 24"W x 11.5"-12.5"H x 11-17.5"D

Weight: 3 lbs.

BRLSPKMD

Fits many 15" molded speakers



Dimensions:
(exterior): 31"W x 15.5"H x 21.5"D
(interior): 28"W x 11.5"-12.5"H x 12-21"D

Weight: 5 lbs.

BRLSPKLG

Fits most larger 15" molded speakers



Dimensions:
(exterior): 32"W x 17.5"H x 17.5"D
(interior): 28.5"W x 15"-13.5"H x 16.5"D

Weight: 4 lbs.



BRLSPKLHW

SPEAKER TROLLEY BAG
Fits most larger 15" molded speakers



- Features:
- Durable Ballistic Nylon Black Exterior
 - Padded Soft Polyester Blend Red Interior
 - Convenient Access Top Speaker Handle Pocket Flap
 - Heavy-Duty Zippers and Zipper Pulls
 - Convenient speaker handle access

Dimensions:
(exterior): 18.5" x 31.25-45.5" x 16"
(interior): 12-17.5" x 29" x 15"

Weight: 9 lbs.

DIGITAL GEAR BAGS

Fits gear such as:

- Up to 17" Laptops
 - Cables and Hard Drives
 - Serato and Traktor Scratch, Interfaces
 - Vinyl, CDs, & Flash Drives
 - Digital DJ controllers such as:
 - Native Instrument Machine
 - Pioneer DDJ-WEGO3
 - DJ Mixers
 - Tabletop CD/Media Players
- (visit our website for complete list)

Dimensions (exterior):
19" x 15.5" x 8"
Weight 6 lbs.



BRLDIGITAL
STANDARD GEAR BAG

FEATURES:

- Reinforced Steel Frame Prevents Vertical Crushing and Sagging
- Fully Padded for Gear Protection
- Adjustable Foam Inserts To Customize Main Compartment to Your Gear
- Additional Padded Carry Bag Included, Main Compartment Int. Dims.: 20" x 14" x 1.5"
- Heavy-Duty Zippers and Zipper Pulls
- Convenient Elastic Band Cable Holders
- Pull-up Handle Sling
- Sturdy Bottom Feet Increases Vertical Stability
- Padded Handle and Shoulder Strap for Extra Comfort
- Main Compartment Interior Dimensions: 21.5" x 3.5" x 14.25"

Fits gear such as:

- Up to 17" Laptops
 - Cables
 - Hard Drives
 - Serato and Traktor Scratch, Interfaces
 - Vinyl, CDs, & Flash Drives
 - DIGITAL MIDI CONTROLLERS such as:
 - American Audio VMS5
 - Denon DN-MC6000
 - Numark Mixtrack 3/ Mixtrack Pro 3
 - Traktor Kontrol S4/S5
 - Pioneer DDJ-RB/SB2
- and much more!

Dimensions (exterior):
23" x 15.5" x 8"
Weight 8 lbs.



BRLDIGITALXL
EXTRA LARGE GEAR BAG
NO SMALL BAG INCLUDED

BRLDIGITALXL
Includes additional carry bag.



BRLDIGITAL2XL
DOUBLE EXTRA LARGE BAG

BRLDIGITAL3XL
TRIPLE EXTRA LARGE BAG



FEATURES:

- Pull-up Handle Rear Sling
- Padded for Gear Protection
- Heavy-Duty Zippers and Zipper Pulls
- Convenient Elastic Band Cable Holders
- Large Front Accessory Compartments with Multiple Pockets
- Dual Handle Straps and Shoulder Strap for Diverse Handling
- Adjustable Foam Inserts To Customize Main Compartments to Your Gear
- Main Compartment Interior Dimensions: 28" x 13.5" x 3.5"
- Laptop / Accessory Compartment Interior Dimensions : 27" x 13"
- Laptop / Accessory Compartment Can Be Separated Into Two Sections with the Removable Foam Strip Divider

Fits DJ controllers such as:
Denon MCX8000
Pioneer DDJ - RZ/SZ
Pioneer XDJ - RX



Fits gear such as:

- Cables
 - Hard Drives
 - Tablets
 - Vinyl, CDs, & Flash Drives
 - A Wide Variety of Laptops of Various Sizes
 - Serato and, Traktor Scratch Interfaces
 - Laptop Stands Such as Odyssey's Folding L Stand 360
 - Digital DJ Controllers Such as:
 - Numark Mixdeck Express
 - Numark Mixdeck Quad
 - Pioneer DDJ-RX / SX / SX2
- (visit our website for complete list)

Dimensions (exterior):
28" x 14" x 5.5"
Weight 4 lbs.





DIGITAL GEAR COURIER BAG

The Redline Tech bag lets you take all your digital essentials from one gig to the next. It has enough compartments and pockets to store an Odyssey LSTANDM or LSTAND360 laptop stand as well as your laptop, microphones, interfaces, cables, hard drives, headphones, vinyl, and much more. Fully padded in all the right places with a reinforced frame for the ultimate in digital gear protection.



BRLTECH

Dimensions (exterior):
18"W x 15"H x 4"D
Weight 6 lbs.

Features and specs:

- Fully Padded for Gear Protection
- Reinforced Protective Frame Prevents Sagging
- Dedicated Adjustable Compartment for Laptop
- Dedicated Folding compartment
- Heavy-Duty Zippers and Zipper Pulls
- Includes Clear Mesh Interior Pockets
- Pull-up Handle Sling
- Adjustable Exterior Folding Flap
- Easy Access Front and Rear Pockets
- Sturdy Bottom Feet Increases Vertical Stability
- Padded Handle and Shoulder Strap for Extra Comfort

Fits gear such as:

- Up to 17" Laptop
- Cables
- Turntable Needle Cartridge Case
- Hard Drives
- iPad
- Serato and Traktor Scratch Interfaces
- Laptop Stand (LSTANDM or LSTAND360)
- Vinyl, CDs, & Flashdrive and much more!



BRLDJA



- Stong Exterior for Gear Protection
- Multiple Compartments for Storage
- Single Carrying Handle and Padded Shoulder Strap
- 19" x 20" x 13" 6 lbs.



BDIGI

DIGITAL GEAR POUCH

FEATURES:

- 3D Screen Print Design
- Made of Neoprene Material That Stretches to Fit Your Gear
- Plush Soft Fabric Suede Interior
- Heavy-Duty Zipper & Zipper Pulls
- Main Compartment Int. Dims 8" x 2" x 6.5"
- 7.5" x 4.5" Exterior Pocket

THUMB DRIVE UTILITY POUCHES



BTDP2

- Dual Pocket Thumb Drive Pouch with key chain hook



BTDP6

- Six pocket thumb drive utility pouch

HEADPHONES/UTILITY POUCH

Keep your headphones looking new with our Headphone Pouch. Also great for holding any type of small gear you don't want to lose or get scratched up.



Also fits the Serato Scratch Live as well as other laptop interfaces and pocket hard drives!

BHP

- Dims: 7.5" x 0.25" x 9.5"

REMOVABLE RACK SHELL BAGS

Our Rack Bags are made of an 800 Denier ballistic nylon covering that withstands the challenges of constant transport. Stylish zipper pulls are chrome plated and can be locked together for added security. A roomy outside zippered pocket allows for storage of all the essentials such as mics, cables, etc. Absolutely the best rack bag ever designed and built for the music industry professional.



BR308

FEATURES:

- complete access to front & back of racked gear
- comfortable shoulder strap
- front pocket storage compartment

Available in:

MODEL	SPACE	DIMENSIONS	RACKABLE DEPTH	WEIGHT
BR308	3U	22" X 7" X 10"	8"	10 lbs.
BR312	3U	22" x 7" x 14"	12"	12 lbs.
BR316	3U	22" x 7" x 18"	15"	15 lbs.
BR408	4U	22" x 9" x 10"	8"	12 lbs.
BR412	4U	22" x 9" x 14"	12"	16 lbs.
BR416	4U	22" x 9" x 18"	15"	19 lbs.
BR512	5U	22" x 10.5" x 14"	12"	21 lbs.
BR516	5U	22" x 10.5" x 18"	15"	23 lbs.



BR412



Our unique rack bags allow you to remove the interior hard shell from the padded bag so you can stack racks firmly on top of each other without the bag getting in the way! All rack bags include a shoulder strap along with a small bag of rack screws and washers.



The black carpet covered interior shell is studio furniture friendly - no rubber feet or metal edges to damage or mark surfaces.



Odyssey rack bags allow for both front and rear access without removing the interior shell.

DOLLY PLATES

Our rugged dolly plates feature heavy-duty casters and two super stop brakes. Save your back and roll into your next gig with ease.

Haul EVERYTHING you need on the ADP2448C (Strap and equipment not included)



ADP2448C



FZWMP



FZADP



ADP30E



ADP30P

MODEL	DESCRIPTION	DIMENSIONS	WEIGHT
ADP2448C	(4) 4.0 in. pro casters	48" x 24" (Carpeted)	35 lbs.
ADP30E	(4) 3.0 in. regular casters	21" x 24"	12 lbs.
ADP30P	(4) 3.0 in. pro casters	21" x 24"	15 lbs.
FZADP	(4) 3.5 in. pro casters	20.5" x 24" (for Flight Zone Amp Racks)	18 lbs.
FZWMP	(4) 3.5 in. pro casters	20.5" x 21.25" (for Flight Zone Combo Racks)	18 lbs.

ROCK N ROLLER® MULTI-CART®

An Essential for DJs

Moves huge amounts of gear.
Folds small for easy storage.
High-tech swivel caster.
Dependable steel frame.



Best selling equipment cart in the music industry!

Wide air-filled all-terrain wheels help navigate grass and gravel



Two-wheeler configuration takes steps easier with the help of a built-in stair-stepper bar.



Most DJ's can move all of their gear, including PA, in one trip.



Optional top shelf & lower deck kits add on-site versatility



Perfect behind-the-scenes work desk for running lights, show production & recording.

Instantly transforms into any of eight configurations



Tough, textured finish resist equipment slippage.



ROCK N ROLLER® MULTI-CARTS® 8-IN-1 EQUIPMENT TRANSPORTS



OR2RT
OR2-MICRO MULTI-CART: Frame telescopes from 26"-39" in length with 25"/20" (front/rear) foldable sides. 6"x1.50" rear wheels and 4"x1.0" front swivel casters. Load capacity: 350 lbs./24 cu. ft. Weight: 17 lbs.



OR6RT
OR6-MINI MULTI-CART: Frame telescopes from 28"-42.5" in length with 24" foldable sides. 8"x2.50" pneumatic rear wheels and 4"x1.0" front swivel casters. Load capacity: 500 lbs./27 cu. ft. Weight: 25 lbs.



OR8RT
OR8-MID MULTI-CART: Frame telescopes 34"-52" in length identical to R10 except with 8"x2.50" pneumatic rear wheels resulting in 20% smaller storage footprint than OR10. Load capacity: 500 lbs./32 cu. ft. Weight: 29 lbs.



ORSH10
ORSH10-EXPANDABLE SHELF KIT: Converts a Multi-Cart in seconds into long (52"x18") or short (34"x18") shelf cart. Shelf quickly detaches and breaks down for small storage (30"x18"x2"). Carpet-covered 1/2" plywood with powder-coated. Weight: 16 lbs.



ORMH1
ORMH1 MINI HAND TRUCK. Dimensions: 24"x14.5"x6.75" (folded). 39"x14.5"x 24.75" (expanded) Load Capacity: 200 lb. Weight: 9.6 lbs.



OR10RT
OR10-MAX MULTI-CART (BEST SELLER): Frame telescopes 34"-52" in length with 32" foldable sides to stack loads high. 10"x3.0" pneumatic rear wheels. 5"x1.25" front swivel casters. Load capacity: 500 lbs./32 cu. ft. Weight: 31 lbs.



OR12RT
OR12-ALL-TERRAIN MULTI-CART: Frame telescopes 34"-52" in length with 32" foldable sides to stack loads high. 10"x3.0" pneumatic rear wheels and 8"x2.50" pneumatic swivel casters. Load capacity: 500 lbs./32 cu. ft. Weight: 36 lbs.



OR14G
OR14 MEGA MULTI-CART: Frame telescopes from 42"-60" in length with 32" foldable sides. 8"x2" R-Track rear wheels with no-flat tires and 6"x1.50" front swivel casters with brake. Load capacity: 700 lbs./24 cu. ft. Weight: 36 lbs.



OR16RT
R16RT GROUND GLIDER MAX. Frame telescopes from 34"-52" in length with 32" foldable sides. 8"x3" R-Trac wide no-flat rear wheels and 6"x3" R-Trac wide no-flat swivel casters with brake. Load cap.: 600 lbs./32 cu. ft. Weight: 33 lbs.



OR18RT
R18RT GROUND GLIDER MEGA. Frame telescopes from 42"-60" in length with 32"/20" (front/rear) foldable sides 10"x3" R-Trac wide no-flat rear wheels and 8"x3" R-Trac wide no-flat swivel casters with brake. Load cap.: 700 lbs./32 cu. ft. Weight: 38 lbs.

COMPACT BACKLIT COLOR CHANGING LED KEYBOARDS

ControlSL™

U.S. and Foreign Patent Pending

Serato Scratch Live DJ's as well as Traktor Scratch (2nd Gen. or later Only) users are now in total control with Odyssey's Control SL keyboard controller. Easy to manipulate color coded shortcut keys allow you the artist to be more creative and have the flexibility to concentrate on what matters, the music.



*Laptop is not included



Easily visible color coded Serato shortcut key layout for both left and right CD/turntable decks



3 additional USB ports. Great for any Guest DJ's USB Hard drive Connectivity!

KEY FEATURES:

- PC & MAC compatible
- Easily visible color coded Serato shortcut key layout for both left and right CD/turntable decks.
- 7 Color Backlit LED keys great for visibility in any dark club environment. Set your color preference or choose from two built-in color changing modes.

- Connect up to 3 additional USB devices
- Compatible Serato Scratch Live DJ and Traktor Scratch
- 12.625"W x 0.375-0.875"H x 6.75"D
- Weight: 1 lb.

MODEL	WEIGHT	DESCRIPTION
COLORKEY	1 lb.	Compact color-changing LED keyboard
CONTROLSKIN	0.5 lb.	Serato / Traktor Scratch keyboard skin for the COLORKEY
CONTROLSL	1 lb.	Compact color-changing LED keyboard with Serato Shortcut Printed Keys
CONTROLKIT	3 lbs.	COLORKEY & COLORSKIN all-in-one package

Visit our website for more details on these items.

ColorKey™
Compact LED Keyboard

U.S. and Foreign Patent Pending



COLORKEY FEATURES:

- PC & MAC compatible
- 7 Color Backlit LED keys great for visibility in any dark club environment. Set your color preference or choose from two built-in color changing modes
- Connect up to 3 additional USB devices
- Power supply adaptor and Sleek Keyboard pouch included
- 12.63"W x 0.38-0.88"H x 6.75"D



Power adaptor and keyboard pouch included with COLORKEY

ControlSkin™

U.S. and Foreign Patent Pending

CONTROLSKIN FEATURES:

- Made for Colorkey
- Clear non-slip rubber construction
- Serato / Traktor Scratch shortcuts
- Can be placed or removed over the ColorKey quick and easy in no time at all.



7 Color LED lit keys great for visibility in any dark club environment



3 additional USB ports. Great for any Guest DJ's USB hard drive Connectivity!

ControlKit™ LED KEYBOARD & CONTROL SKIN KIT

Compact LED Keyboard

KIT INCLUDES:



CARPET FOLD-OUT FACADES AND STANDS

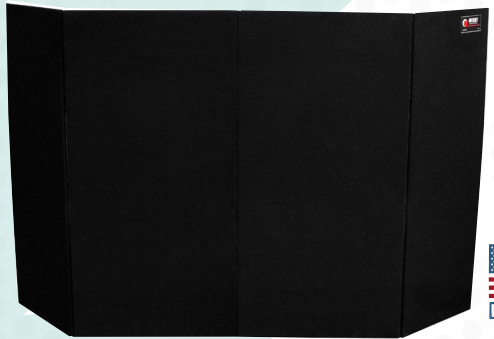

NEW



handle shelf folds down for easy carrying



heavy-duty custom clip holds shelf in place for stability and storage



sides fold in for compact transport

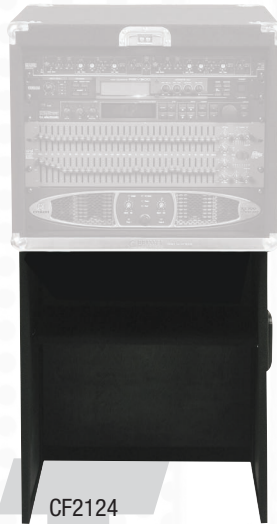

- Made of multi-layered plywood
- Covered with heavy-duty Carpet
- Easy to set-up and tear down
- 180 lbs. maximum load (evenly distributed)

Our carpeted series facades are ideal for clean setup presentations. They're perfect for covering your DJ coffin, DJ controller, or combo rack set including stands, cables, and other gear from the audience during those special event occasions that require it most.

MODEL	DIMENSIONS	WEIGHT	BEST USED FOR:
CF2124	21" x 24" x 17.5"	26 lbs.	racks, cases, and consoles
CF2128	21" x 28" x 17.5"	28 lbs.	racks, cases, and consoles
CF2636	26" x 36" x 16"	32 lbs.	coffin, consoles
CF3630	36" x 30" x 17.5"	38 lbs.	coffin, consoles
CF3634	36" x 34" x 17.5"	40 lbs.	coffin, consoles
CF4848	48" x 48" x 18.5"	37 lbs.	façade (no center shelf)
CF6048	60" x 48" x 18.5"	50 lbs.	façade (no center shelf)

FOLD-OUT STANDS AND TABLE

• FLIGHT ZONE® SERIES



FZF1926
Perfect for DJ Coffins, Consoles, and Combo Racks

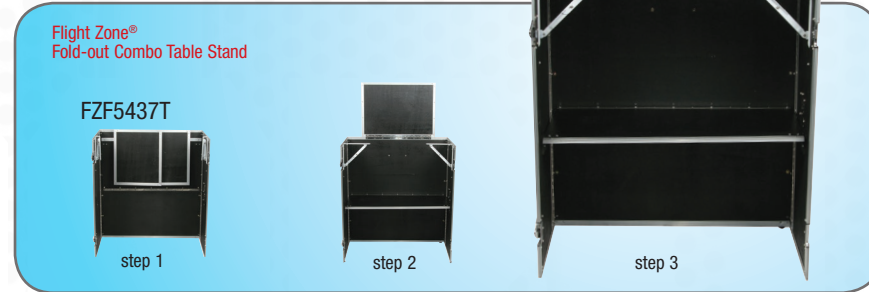
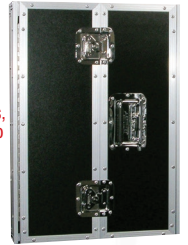

Our Flight Zone® folding table stands are perfect companion pieces for the DJ who likes to go completely modular. Use for a home studio set up or on stage. Showing off your gear and talent never looked better with our fold-out table stands. Made of black laminate and aluminum valance edging, these stands provide a clean, professional appearance that's easy to setup and teardown. Black Label® Series also available.



MODEL	DIMENSIONS	WEIGHT
FZF1930	(Exp'd) 19" X 30" X 18.5"	26 lbs.
FZF1926	(Exp'd) 19" x 26" x 18.5"	22 lbs.
FZF2136	(Exp'd) 21" x 36" x 18.5"	30 lbs.
FZF2636	(Exp'd) 26" x 36" x 18.5"	30 lbs.
FZF3336	(Exp'd) 33" X 36" X 18.5"	33 lbs.
FZF5437T	(Exp'd) 54" x 37" x 18.5"	45 lbs.

X STAND

Features a two tier top Laptop Tray system that allows you to use your laptop safely and securely during your gig. Available in Black or White finishes. Made of powder coated steel/aluminum, these X stands are lighter for mobile DJ controller setups that don't require a heavy-duty support system.

LUXE
ELEGANT MUSIC PRODUCTS

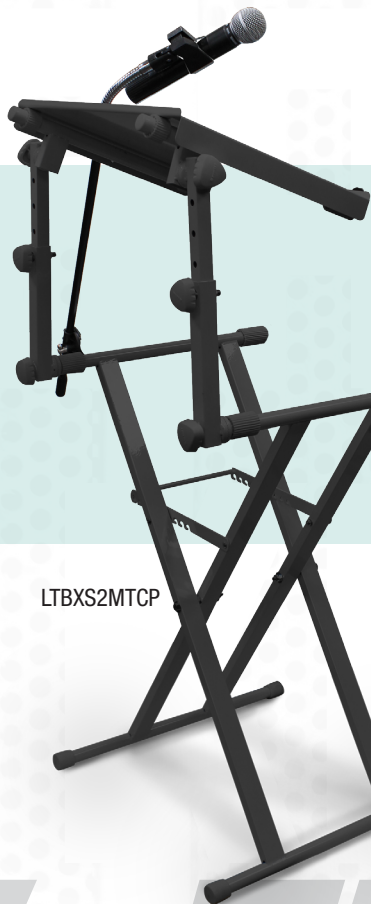

LTBXS2MTCP



LTBXS2MTCPWHT

This integrated goose neck easily attaches in seconds and adjusts to the perfect angle for mic positioning.

Combo pack includes:
(1) X-Stand, (1) mic boom, and (1) laptop tray.

All measurements are approximate. Gear are not included. Designs are subjected to change without notice.

X STAND



The Strongest DJ X STAND in the industry!

Exclusive 10 way adjustable twin bracing design for added strength.



Anti-slip rubber padding helps keep gear in place.



EXCLUSIVE FEATURES

- Designed to support DJ Coffins
- Solid twin steel bracing with extra deep support bars to support larger gear
- Extra deep base for added stability
- Anti-slip rubber pads
- 200 lbs. maximum load (evenly distributed)
- Folded Dims: 15" x 10.25" x 2.75"
- Weight: 20 lbs.

X STAND "TWO"

FEATURES 1" TUBES FOR EXTRA STRONG SUPPORT

The LTBXS2 (X-Stand 2) is versatile and compact, folding into a space smaller than most guitar cases. Each tier allows independent height and width adjustment for holding keyboards, DJ Coffins, CD controllers and even laptops.

Adjustable top tier
width: 22.75-42.50"
height: 14-19.25"
depth: 18.50-21.50"

Other Specs
• 12.5-37.25"W x 18.75-38.2"H x 22.5"D
• Weight: 23 lbs.

Folded Dimensions with top tier
width: 23.50"
height: 59.50"
depth: 3.75"

Folded Dimensions without top tier
width: 23.50"
height: 41"
depth: 3.75"



LTBXS2



LUXE
ELEGANT MUSIC PRODUCTS

LTBXS2WHT
Also available in LUXE white.



LUXE
ELEGANT MUSIC PRODUCTS

LTBXS2WHT
Also available in LUXE white.

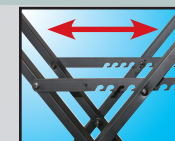

CARPET HEIGHT ADJUSTABLE DJ TABLES

CTBC2048

Use this clean carpeted design work surface to set up your system or music. This classic series Odyssey DJ table measures 48 inches wide and 20 inches deep and comes with a pre-tapped port hole for cable runs and a strap handle for easy carrying. The folding leg system is height-adjustable from 26 to 38 inches. The CTBC2048 can hold 150 lbs.(evenly distributed).

NEW

MODEL	DIMENSIONS	WEIGHT
CTBC2048	48" x 26-38" x 20	26 lbs.



CTBC2060

Use this sturdy and clean looking work surface to set up your system or music. This professional table comes with a pre-tapped port hole for cable runs and a strap-handle for easy carrying. The folding leg system is height-adjustable from 26" to 38"



MODEL	DIMENSIONS	WEIGHT
CTBC2060	60" X 26"-38" X 20"	29 LBS.



TRUSS TABLES

ATT



Our sleek looking DJ Truss tables add that professional studio look to any room. Each are made of high grade aluminum giving them that cool "truss" look. A definite must have for clubs, restaurants or your studio. Features adjustable leveling feet to minimize any rocking or swaying.

FOLD DOWN AND GO IN SECONDS!

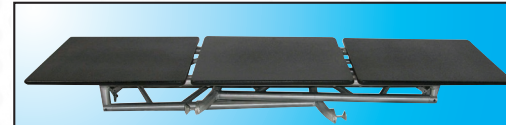

ATT2

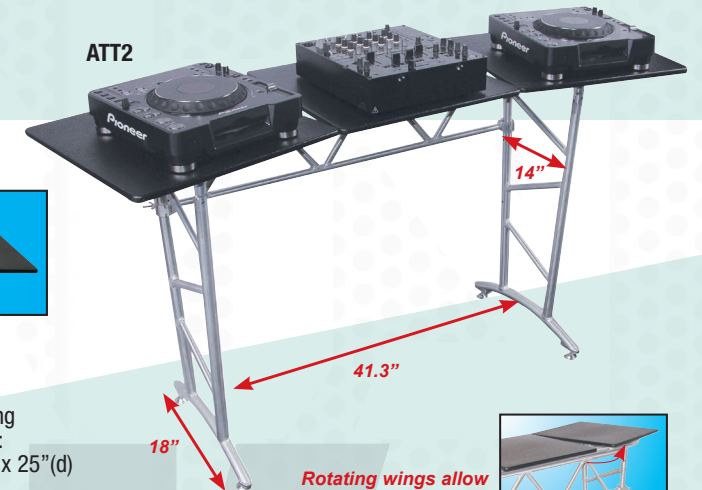

The ATT2 features fold flat portability, and swiveling side platforms. Each of the 3 tabletops measures: 19.5" x 19.5". Together, they measure 66.25"(w) x 25"(d) when sides are fully angled.

MODEL	DIMENSIONS	WEIGHT
ATT	59.25" X 35.25" X 20"	44 LBS.
ATT2	60" X 35.25" X 19.5"	35 LBS.

NEXUS 6" X 6" (15CM X 15CM) SQUARE TRUSS SYSTEM

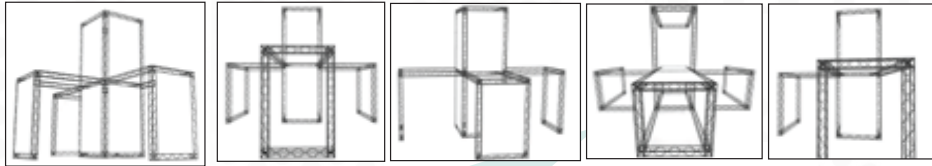

Save Time and Labor While Achieving a Professional Show Setup. With the Nexus Truss System, create professional grade exhibition and show setups with minimal effort. The Odyssey Nexus Truss System is Easy to Setup. Absolutely no tools are required for truss-to-truss assembly. With its compact and lightweight properties, you don't need heavy machinery for transport and handling. An appealing tradeshow set-up can be done easily with only one person. The Odyssey Nexus Truss System is durable. Designed to be disassembled and reused show after show. Don't be fooled by the composite shell. On the inside, the Odyssey Truss System is made with aluminum steel composite construction. That makes it durable strong enough to embellish your setup with banners, lights, and even monitors.

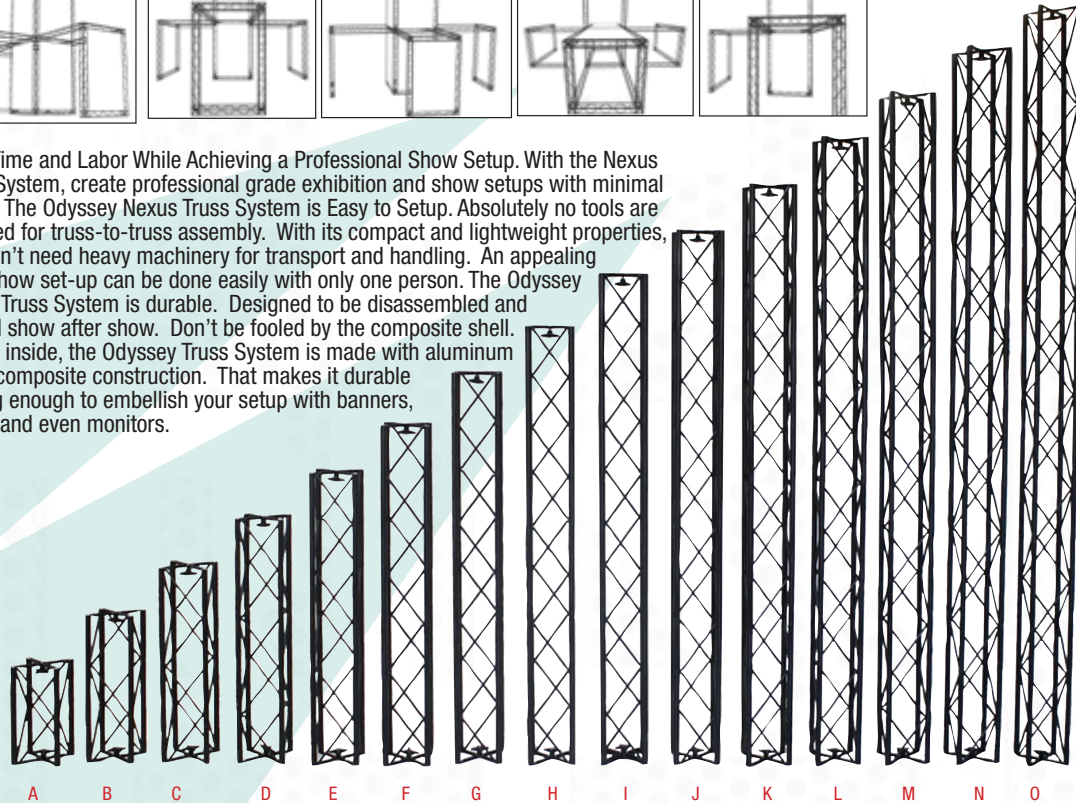

MODEL	LENGTH*in.(cm.)	WEIGHT*(lbs.)	EXT.DIMS.*	
A	NEX1530BLK	12"(30)	1.8	15.91" x 11.94" x 15.91"
B	NEX15045BLK	18"(45)	2.3	15.91" x 17.75" x 15.91"
C	NEX15060BLK	24"(60)	2.8	15.91" x 23.75" x 15.91"
D	NEX15075BLK	30"(75)	3.3	15.91" x 29.44" x 15.91"
E	NEX15090BLK	35"(90)	3.8	15.91" x 35.19" x 15.91"
F	NEX15105BLK	41"(105)	4.3	15.91" x 41" x 15.91"
G	NEX15120BLK	47"(120)	4.8	15.91" x 46.75" x 15.91"

MODEL	LENGTH*in.(cm.)	WEIGHT*(lbs.)	EXT.DIMS.*	
H	NEX15135BLK	53"(135)	5.2	15.91" x 52.5" x 15.91"
I	NEX15150BLK	59"(150)	5.5	15.91" x 58.69" x 15.91"
J	NEX15165BLK	65"(165)	6.2	15.91" x 62.25" x 15.91"
K	NEX15180BLK	71"(180)	6.7	15.91" x 70.31" x 15.91"
L	NEX15195BLK	77"(195)	7.2	15.91" x 75.88" x 15.91"
M	NEX15210BLK	83"(210)	7.6	15.91" x 81.63" x 15.91"
N	NEX15225BLK	89"(225)	8.2	15.91" x 87.75" x 15.91"
O	NEX15240BLK	94"(240)	8.4	15.91" x 93.38" x 15.91"

*approximate

Versatile Odyssey Nexus Truss System. In various truss lengths, there is no limit to your tradeshow set-up size and design. Further enhance your displays with various accessories that the Odyssey Nexus Truss System has to offer.

Key Benefits of the Nexus Truss System:

- Do-it-Yourself show display setup from start to finish
- Durable, lightweight, aluminum steel composite construction
- No tools required for truss-to-truss assembly
- 15 available truss lengths
- Various display accessories available
- Available in black or white color

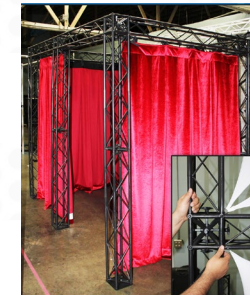

*Drapes not included

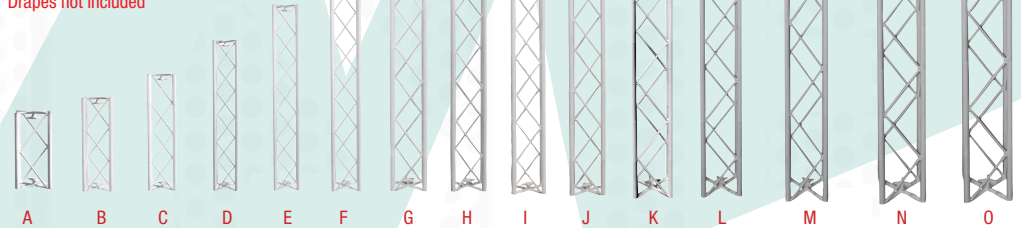

MODEL	LENGTH*in.(cm.)	WEIGHT*(lbs.)	EXT.DIMS.*	
A	NEX1530WHT	12"(30)	1.8	15.91" x 11.94" x 15.91"
B	NEX15045WHT	18"(45)	2.3	15.91" x 17.75" x 15.91"
C	NEX15060WHT	24"(60)	2.8	15.91" x 23.75" x 15.91"
D	NEX15075WHT	30"(75)	3.3	15.91" x 29.44" x 15.91"
E	NEX15090WHT	35"(90)	3.8	15.91" x 35.19" x 15.91"
F	NEX15105WHT	41"(105)	4.3	15.91" x 41.00" x 15.91"
G	NEX15120WHT	47"(120)	4.8	15.91" x 46.75" x 15.91"
H	NEX15135WHT	53"(135)	5.2	15.91" x 52.50" x 15.91"

*approximate

MODEL	LENGTH*in.(cm.)	WEIGHT*(lbs.)	EXT.DIMS.*	
I	NEX15150WHT	59"(150)	5.5	15.91" x 58.69" x 15.91"
J	NEX15165WHT	65"(165)	6.2	15.91" x 62.25" x 15.91"
K	NEX15180WHT	71"(180)	6.7	15.91" x 70.31" x 15.91"
L	NEX15195WHT	77"(195)	7.2	15.91" x 75.88" x 15.91"
M	NEX15210WHT	83"(210)	7.6	15.91" x 81.63" x 15.91"
N	NEX15225WHT	89"(225)	8.2	15.91" x 87.75" x 15.91"
O	NEX15240WHT	94"(240)	8.4	15.91" x 93.38" x 15.91"

NEXUS 6" X 6" (15CM X 15CM) TRUSS SYSTEM CONNECTORS, CUBES, AND ACCESSORIES

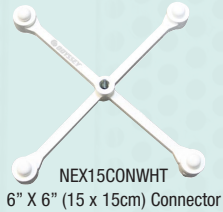

NEX15CONWHT
6" X 6" (15 x 15cm) Connector

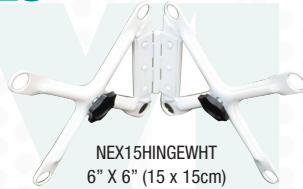

NEX15HINGEWHT
6" X 6" (15 x 15cm)
20-230 Degree Hinge



NEX15CONBLK
6" X 6" (15 x 15cm) Connector



NEX15HINGEBLK
6" X 6" (15 x 15cm)
20-230 Degree Hinge



NEX1545NWHT
6" X 4.5" X 6"
(15 x 11 x 15cm) 45° Connector



NEX1545BLK
6" X 4.5" X 6"
(15 x 11 x 15cm) 45° Connector



NEX15CUBEWHT
6.25" x 6.25" x 6.25"
(15 x 15 x 15cm) Square Cube

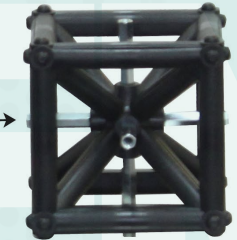

NEX15CUBEBLK
6.25" x 6.25" x 6.25"
(15 x 15 x 15cm) Square Cube



Features and Specs

- Aluminum Steel Composite Construction
- Durable, Compact, and Lightweight
- Easy, Quick Setup Design
- No Tools Require for Truss to Truss Assembly
- Large Selection of Truss Sizes Ideal for Versatile Setup Configurations
- Various Compatible Display Accessories Available



NEXBRHBLK
Brochure Holder

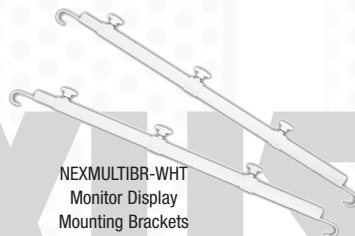

NEXMULTIBR-WHT
Monitor Display
Mounting Brackets



NEXWCLIPTOP-WHT
Top Banner clip



NEXWCLIPBOT-WHT
Bottom Banner clips



NEXMULTIBR-BLK
Monitor Display
Mounting Brackets



NEXWCLIPTOP-BLK
Top Banner clip



NEXWCLIPBOT-BLK
Bottom Banner clips

NEXUS 6" X 6" (15CM X 15CM) TRUSS SYSTEM BASE PLATES



NEXB1560BLK
6" X 24" (15cm x 60cm)



NEXB15WHT
6" X 6" (15cm x 15cm)

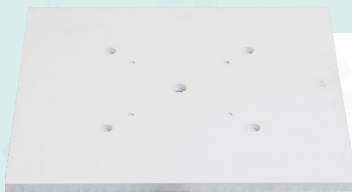

NEXB30WHT
12" X 12" (30cm x 30cm)

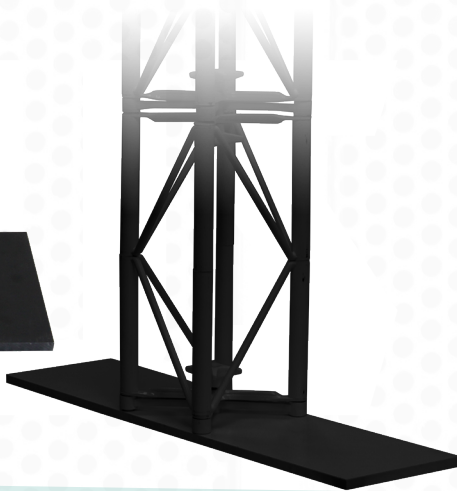

NEXB1560WHT
6" X 24" (15cm x 60cm)

NEXUS BLACK 8" X 8" (20CM X 20CM) FOLDING SQUARE TRUSS SYSTEM

For DJs who want a simple-to-setup truss structure that looks awesome, Odyssey's Patented Nexus Folding Truss is the perfect solution. Like its predecessor, the patented Nexus Folding Truss is versatile and flexible. The modular design can accommodate almost any exhibition or display size that is imaginable. Lightweight and durable, a show display can be setup efficiently and easily. When no tools are required in doing truss-to-truss assembly, any adult can assemble any simple to complex display configuration quickly. The Patented Nexus Folding Truss can do more! Being able to fold flat extends the advantage of the patented Nexus Folding Truss. Allowing even easier effort and efficiency in transport from show to show. Not only does it reduce the need for storage space, it also reduces the shipping cost. The Patented Nexus Folding Truss is the ideal solution in minimizing labor and cost.

Key Benefits of the Patented Nexus Folding Truss:

- Folds flat reducing storage and shipping cost
- Durable, lightweight, aluminum steel composite construction
- Do-It-Yourself show display setup from start to finish
- 9 available truss lengths
- No tools required for truss-to-truss assembly
- Various display accessories available

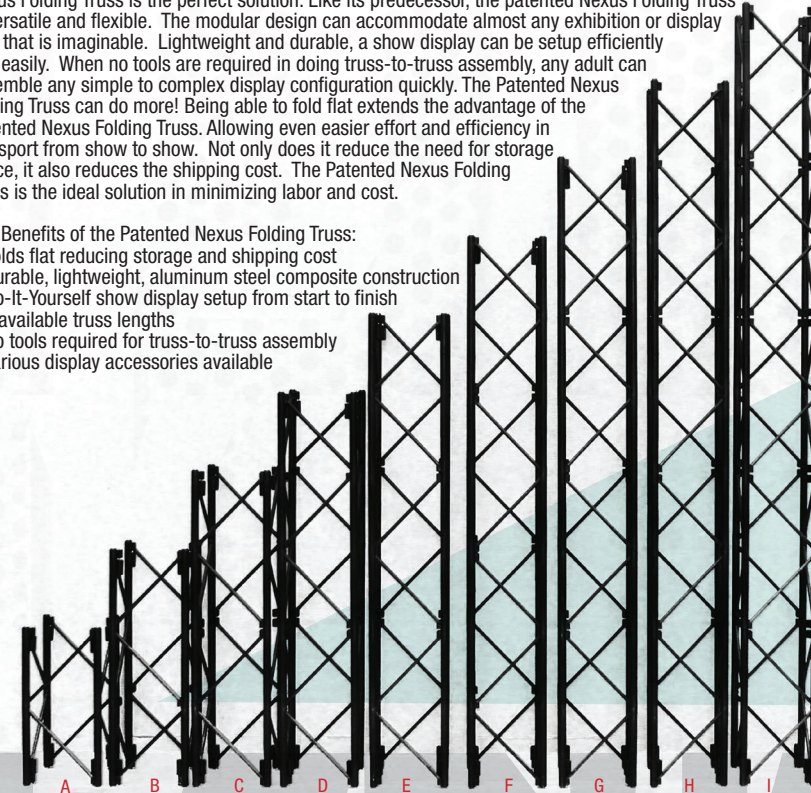

MODEL	LENGTH* in.(cm.)	WEIGHT* lbs.	ETX. DIMS.*
A NEX20040BLK	16"(40)	2.5	7.75" x 15.75" x 7.75"
B NEX20060BLK	24"(60)	3.4	7.75" x 23.62" x 7.75"
C NEX20080BLK	32"(80)	4.5	7.75" x 31.50" x 7.75"
D NEX20100BLK	39"(100)	5.4	7.75" x 39.37" x 7.75"
E NEX20120BLK	47"(120)	6.4	7.75" x 47.24" x 7.75"
F NEX20140BLK	55"(140)	7.4	7.75" x 55.12" x 7.75"
G NEX20160BLK	63"(160)	8.4	7.75" x 62.99" x 7.75"
H NEX20180BLK	71"(180)	9.4	7.75" x 70.87" x 7.75"
I NEX20200BLK	79"(200)	10.4	7.75" x 78.74" x 7.75"

*approximate

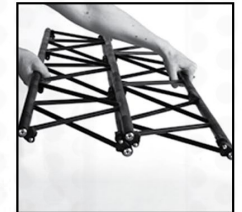

stores & ships flat

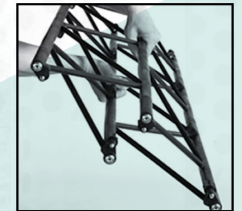

easy to unfold



unfolds to square shape

NEXUS TRUSSBLACK 8" X 8" (20 X 20CM) CONNECTOR, CUBE, AND BASE PLATES



NEX20CUBEBLK
8" x 8" x 8"
(20 x 20 x 20 cm) Square Cube



NEX20CONBLK
8" x 8"
(20 x 20 cm) Connector



NEX20B20BLK
8" x 8" (20 x 20 cm)



NEX20B40BLK
16" x 16" (40 x 40 cm)



NEX20B4080BLK
16" x 32" (40 x 80 cm)



NEX25CUBEBLK
NEXUS DJ TRUSS - BLACK
10" x 10" x 10" (25 x 25 x 25 cm)
SQUARE CUBE CONNECTOR

MODEL	LENGTH* in.(cm.)	WEIGHT* lbs.	ETX. DIMS.*
A NEX25050BLK	20"(50)	3.4	10" x 20" x 10"
C NEX25075BLK	30"(75)	4.5	10" x 30" x 10"
D NEX25100BLK	40"(100)	5.4	10" x 40" x 10"
E NEX25125BLK	50"(120)	6.4	10" x 50" x 10"
F NEX25150BLK	60"(140)	7.4	10" x 60" x 10"
G NEX25175BLK	69"(160)	8.4	10" x 69" x 10"
H NEX25200BLK	79"(180)	9.4	10" x 79" x 10"
I NEX20250BLK	99"(200)	10.4	10" x 99" x 10"
J NEX25CONBLK	10"CONNECTOR	1	10" x 1.5" x 10"
K NEX25CUBEBLK	10" CUBE	7	10" x 10" x 10"

*approximate

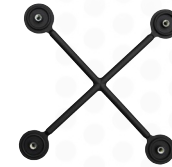

NEX25CONBLK
NEXUS DJ TRUSS - BLACK
10" x 10" (25 x 25 cm)
CONNECTOR

Introducing the Odyssey Nexus Truss System, the ultimate display kit for DJ Setups and photo booth backdrops. The Nexus system has a unique and versatile portable design that addresses all of today's modern DJ and mobile photo booth industries' trussing and backdrop needs. Based on an easy building block concept and given its compact lightweight properties, regardless the arrangement, big or small, complex or simple, Odyssey's Nexus Trussing System provides a quick setup and breakdown solution while enhancing image and presentation.

- Aluminum Steel Composite Construction
- Durable and Lightweight
- Easy, Quick Setup Design
- No Tools Required for Truss to Truss Assembly
- Large Selection of Truss Sizes Ideal for Versatile Setup Configurations
- Various Compatible Display Accessories Available

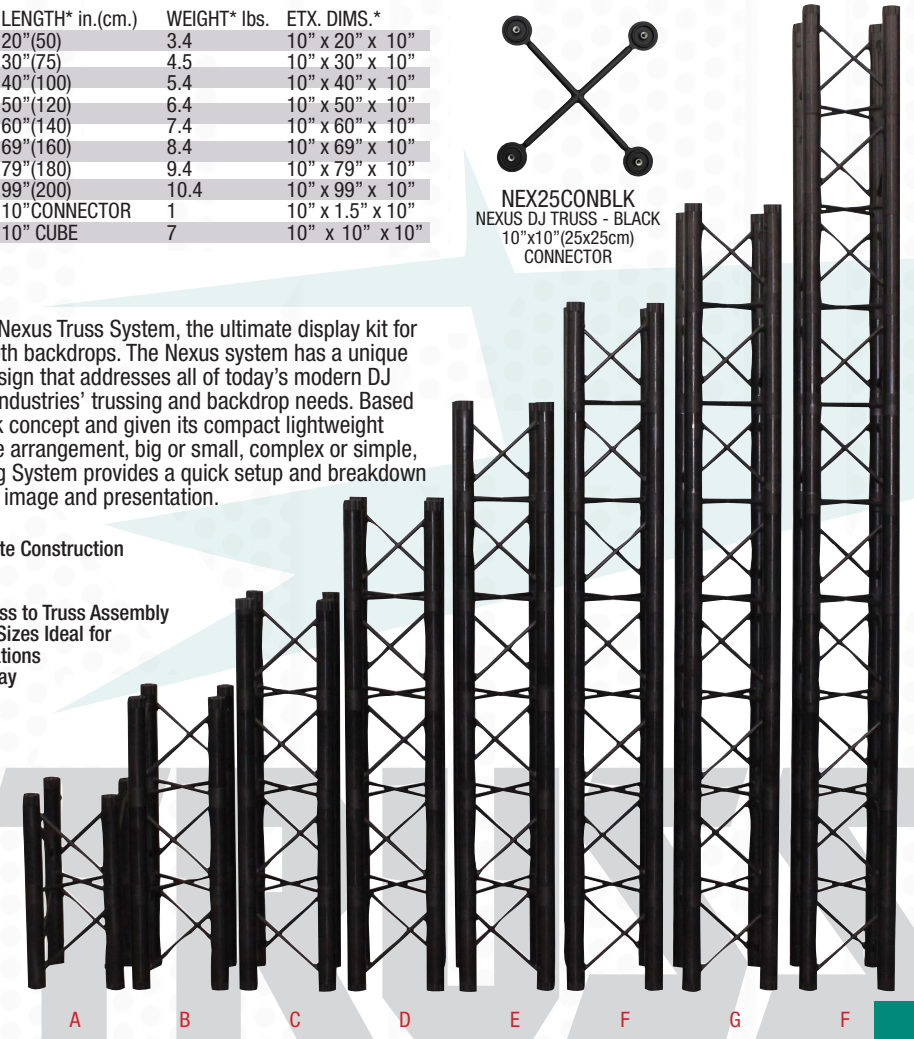

DESIGNER SERIES **DJ** LSTAND LAPTOP STANDS & ACCESSORIES

Make a statement that screams louder than COOL with the LSTAND Designer DJ™ Series. We've added a sharp twist to the "original" ever popular adjustable DJ laptop stand design. Now you can choose from a wide spectrum of colors to fit your personality, your image, and your style.



LSTAND-M*
Folding L Stand system with table/case clamps



LSTAND*
Includes LSTAND CLAMPS for table and case clamp configuration
(*See below for all available colors)

LSTAND

***COLORS FOR DESIGNER DJ™ SERIES LSTANDS & ACCESSORIES:**
Check with your local dealer for availability

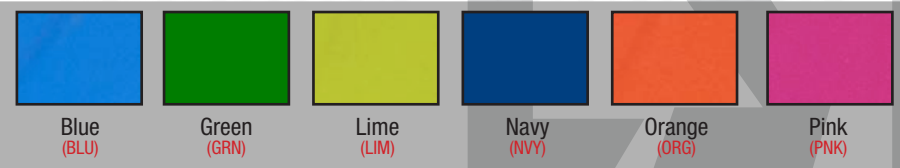

LSTAND CLAMPS*
Pair of clamps available separately
(*See below for all available colors)



LSTAND-S*
Stand alone laptop stand
(*See below for all available colors)

Our LSTAND is the most versatile laptop stand on the market! Our unique design allows for three basic configurations: table top, clamped to a table, or clamped to the wall of a case or other sturdy vertical structure. Set it low for a minimal clearance of 6.75" or set it up to 11.5" high. The 10.75" long support arms hold gear with a width of 9" or greater.

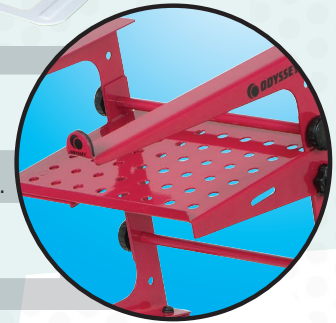

LSTAND TRAY*
Optional accessory tray
(*See below for all available colors)

MODEL	WEIGHT	DESCRIPTION
LSTAND*	6 lbs.	6 Stand with table/case clamps
LSTANDCLAMPS*	2 lbs.	pair of table/case clamps for L Stands
LSTANDM*	6 lbs.	Folding L Stand system with table/case clamps
LSTAND-S*	5 lbs.	Stand alone L Stand
LSTANDTRAY*	2 lbs.	Ventilated adjustable tray for Serato Interface, hard drive or other gear



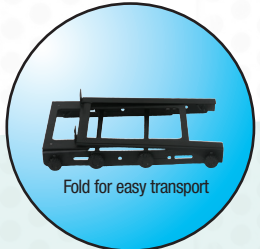

Fold for easy transport



Set-up in a snap!



Adjustable height

L STAND M

U.S. and Foreign Patent Pending

The Odyssey L STAND MOBILE is a light and portable folding stand to place your laptop, CD player/controller, EFX/Drum machines or lighting controller. Odyssey's LSTAND MOBILE comes complete with stand alone legs for a table top configuration and clamps so it can be attached to the edge of a table or the wall of your case just the way you like.



*Shown with optional Lstand tray.

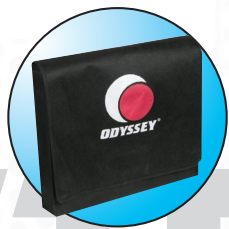

Handy travel pouch included



Case Clamp Configuration with optional Lstand tray shown



Corner Case Clamp Configuration



Our LSTAND is the most versatile laptop stand on the market! Our unique design allows for three basic configurations: table top, clamped to a table, or clamped to the wall of a case or other sturdy vertical structure. Set it low for a minimal clearance of 6.75" or set it up to 11.5" high. The 10.75" long support arms hold gear with a width of 9" or greater.



Stand alone configuration shown with optional L Stand Tray for Serato or other audio interface

Table Clamp Configuration

Case Clamp Configuration



Minimum Width: 10.5"
Maximum Width: 13.5"

Minimum Height: 9.5"
Maximum Height: 14.5"

OPTIONAL: L Stand TRAY

Keep your interface or controller ventilated and close at hand with this adjustable tray. Great for Serato/Traktor interfaces and other DJ gear.



Back View



Front View

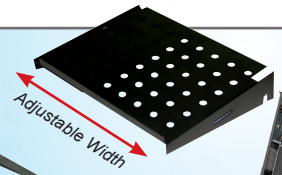

Adjustable Width



Lstand-s

Lstand

Lstand Combo

Lstand tray



Includes Clamps for table/case Configuration

MODEL	WEIGHT	DESCRIPTION
Lstand	6 lbs.	L Stand with table/case clamps set
Lstandclamps	2 lbs.	pair of table/case clamps for L Stands
Lstandcombo	8 lbs.	L Stand with table/case clamps and Lstand Tray set
Lstand M	7 lbs.	Folding L Stand with table/case clamps set
Lstand-S	5 lbs.	Stand alone L Stand
Lstandtray	2 lbs.	Ventilated adjustable tray for Serato, Traktor and other DJ gear.

TURNTABLE CARTRIDGE CASES



ULTRA™ LSTAND 360

Multi-adjustable heights and operation positions

The most flexible laptop stand ever made. Perfect for today's jet-set mobile DJ's. The lightest in the industry with the quickest adjustable set up of multiple heights and angles. No assembly required.

- Features and Specs:
- Weighs only 2 lbs.
 - Adjustable Frame Heights
 - 360 Degree Rotating Support Arm and Base
 - Quick Locking Positions



U.S.A. and Foreign Patents pending



LSTAND 360*
* Mac silver, black, or white

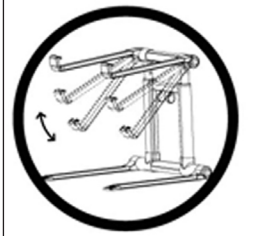
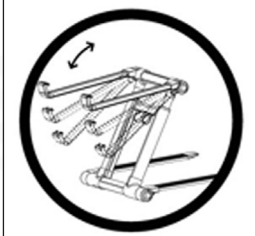
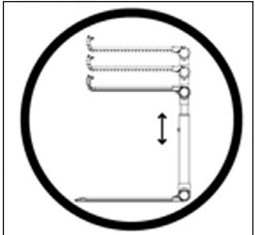

Fold Flat



Odyssey's Krom™ KCC PRO cases protect your most valuable spinning tools with functional style. Whether you have Shures, Ortofons, Stantons, Technics etc...you'll have no worries with them suspended on the cartridge bayonet holders securely held in place and cushioned by soft density cartridge lid egg foam. Also includes a compartment for your spare needles just in "case".

MODEL	DIMENSIONS	WEIGHT	DESCRIPTION
KCC2PR2BL	5.5" x 2.125" x 4.5"	0.55 lb	Holds 2 Turntable Needle Cartridges plus spare styli
KCC2PR2SD	5.5" x 2.125" x 4.5"	0.55 lb	Holds 2 Turntable Needle Cartridges plus spare styli
KCC2PR2SL	5.5" x 2.125" x 4.5"	0.55 lb	Holds 2 Turntable Needle Cartridges plus spare styli
KCC4PR2BL	8.25" x 2.125" x 4.5"	1 lb	Holds 4 Turntable Needle Cartridges plus spare styli
KCC4PR2SD	8.25" x 2.125" x 4.5"	1 lb	Holds 4 Turntable Needle Cartridges plus spare styli
KCC4PR2SL	8.25" x 2.125" x 4.5"	1 lb	Holds 4 Turntable Needle Cartridges plus spare styli
VUXS2	9.25" x 2.5" x 5.25"	0.6 lbs	Water-tight, Dust-proof and Impact-resistant Utility Carrying Case



KCC PRO's feature a spare styli compartment



KCC2PR2SD silver diamond exterior design



KCC4PR2SD silver diamond exterior design



VUXS2 water-tight, dust-proof and impact-resistant utility carrying case

BATTLE TRAYS

Our 10" & 12" Battle Trays are perfect for setting up a mixer between two cases, raising the mixer surface to allow easier access and quicker moves. Essential for battle DJs using 10" & 12" format mixers.

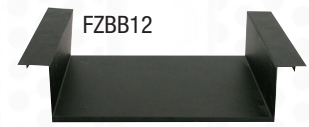

FZBB12



MODEL	DIMS	WEIGHT	DESCRIPTION
FZBB10	12.75" x 3.5" x 19"	1 lb.	10" format mixer Battle Tray
FZBB12	14.75" x 3.75" x 19"	1 lb.	12" format mixer Battle Tray

HEAVY-DUTY LAPTOP/GEAR STANDS AND ACCESSORIES

Elevate your laptop and pro audio gear in style with our heavy-duty L-Evation stands. L-Evation stands are easy to assemble and customize with their adjustable height and strong support arm. Set it up over your turntable, mixer, etc. to give you comfortable, easy access to more tabletop gear.



LUNISP

This universal L-Elevation stand has adjustable depth support for your laptops, most tabletop CD players, effects units, and other pro gear.

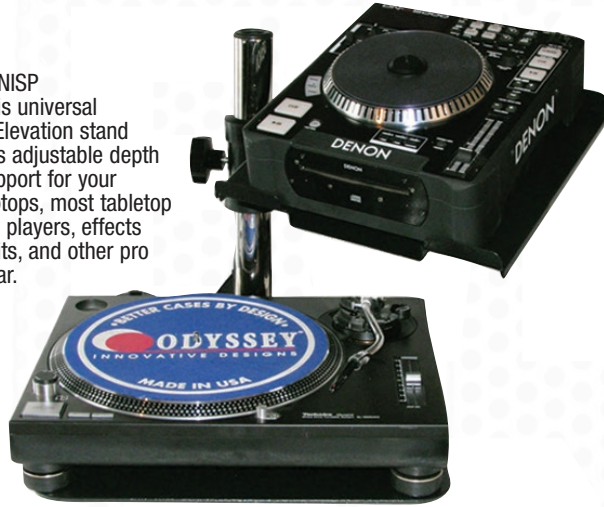

Dual Arm Package



LUNISPDB

- Includes:
- 2 LUNIPLATES
- 1 LDBARM
- 1 L16POLE
- 1 L20POLE
- 1 LBASE



Triple Arm Package

L3UNI

- Includes:
- 1 LUNISP
- 2 LUNIPLATE
- 1 LDBARM
- 1 L20POLE

L16POLE

16" long accessory pole for L-Evation stands

L20POLE

20" long accessory pole for L-Evation stands

LDBARM

Double arm accessory for L-Evation stands

L-Evation Packages:

MODEL	WEIGHT	DESCRIPTION:
LUNISP	32 lbs.	Universal L-Elevation Stand with adjustable depth can accommodate a laptop, most table top CD Players, effect units or other pro gear
LUNISPDB	54 lbs.	Dual Universal plate package
L3UNI	63 lbs.	Triple Universal plate package

L-Evation Stand Parts:

MODEL	WEIGHT	DESCRIPTION:
LARM	4 lbs.	Accessory Dual Arm for L-EVATION* Stand
LBASE	15 lbs.	Base for L-Evation stand
LDBARM	6 lbs.	Accessory Dual Arm for L-EVATION* Stand
LUNIPLATE	7 lbs.	Universal Plate holds most Laptops, CD decks, Effect units, and Mixers.
L20POLE	6 lbs.	20" pole (five inches taller than the standard pole)
L16POLE	5 lbs.	16" pole (standard pole for L-Evation stand)

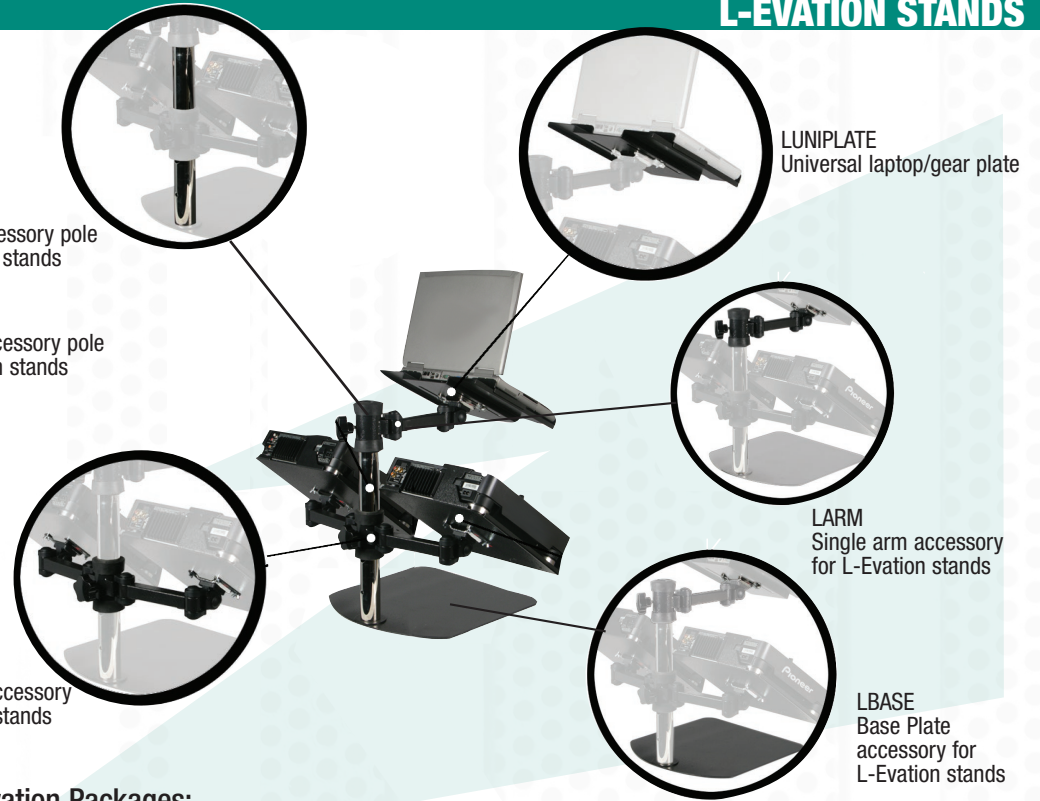

LUXE™
SERIES

“IT’S A NICE DAY FOR A
WHITE WEDDING”



Introducing the **Luxe™ Series** of professional all white music products geared towards the **professional wedding DJ, Houses of worship** and **elegant presentations.**

ODYSSEY
LEADING THROUGH INNOVATION

ODYUSA
INNOVATIVE DESIGNS

TRIPOD STANDS
LIGHTING STANDS & ACCESSORIES

LUXE™
ELEGANT MUSIC PRODUCTS

BLTUNI

Odyssey Universal
Tripod Stand Bag
Dim: 12" x 63.5"
For all Odyssey
single tripod stands.
Drawstring closure.



LTP2WHT



LTP6WHT



LTP1

LTP1 12 FT TRIPOD

Black high quality aluminum/steel and Lighting tripod stand with 1 T-bar, (2) side bars & support bars

- Tripod extends to 12 feet
- Folds up for easy transport
- Maximum load capacity 100 lbs. evenly distributed
- Includes 8 hanging bolts
- Weight: 14 lbs.

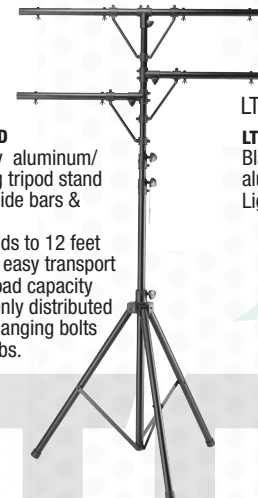

LTP2

LTP2 12 FT TRIPOD

Black high quality aluminum/steel Lighting tripod stand

- Single T-bar with support bars & (4) hanging bolts
- Tripod extends 12 feet
- Folds up for easy transport
- Maximum load capacity 80 lbs. evenly distributed
- Weight: 12 lbs.

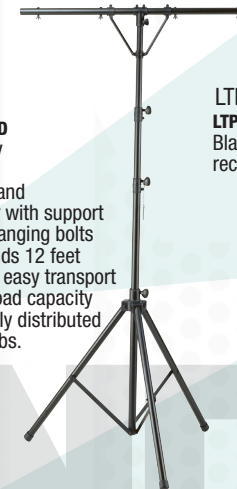

LTP6

LTP6 9 FT TRIPOD

Black Lighting tripod stand Highly recommended for pin spot and par cans

- Single T-bar with (4) hanging bolts
- Tripod extends to 9 feet
- Folds up for easy transport
- Maximum load capacity 60 lbs. evenly distributed
- Weight: 11 lbs.

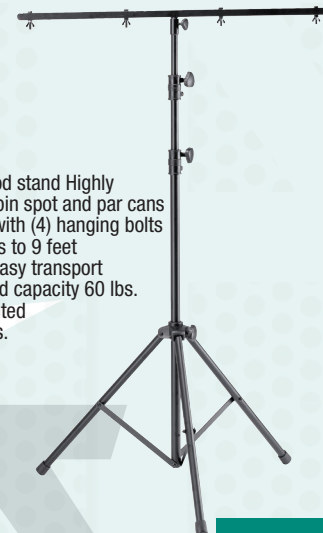

MOBILE TRUSS SYSTEMS

LTIBEAM

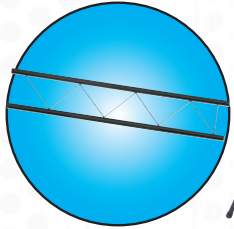

Add this 5 foot truss to extend your 10 foot system to 15' span

- Truss bar diameter is 1.5"
- Hardware included
- Weight: 9 lbs.

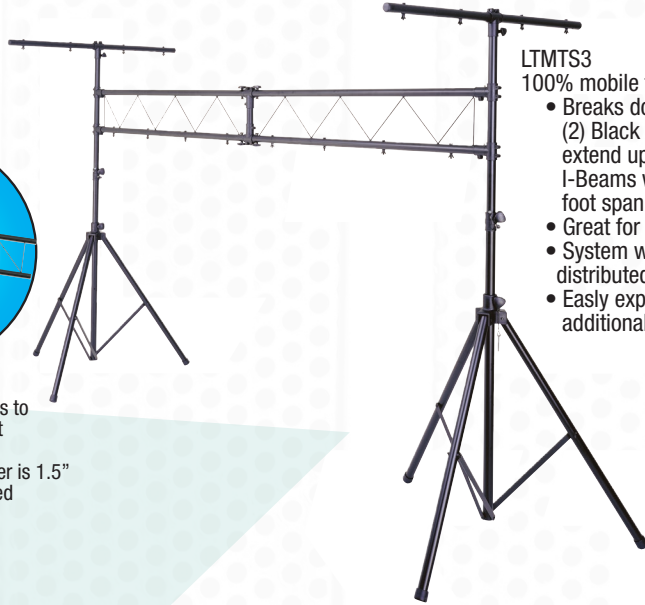

LTMTS3
100% mobile truss system features:

- Breaks down into 6 portable pieces: (2) Black aluminum/steel tripods which extend up to 9 feet. (2) 5 foot truss I-Beams when connected have a 10 foot span & (2) T-bars
- Great for bands and mobile DJs
- System weight capacity when evenly distributed is 200 lbs.
- Easily expandable to 15 ft span with an additional LT-IBEAM accessory.

BLTMTS

Specially designed to carry a mobile trussing system. Also great for storing other accessories such as tall cymbal stands, mic boom stands, tripod, etc.



BRLTMTSW

Tote Bag with end wheels on one side and a handle on the other. Roll your mobile system to and from your vehicle and gig! Holds up to 100 lbs. max. Interior Dims: 65" x 9" x 11"

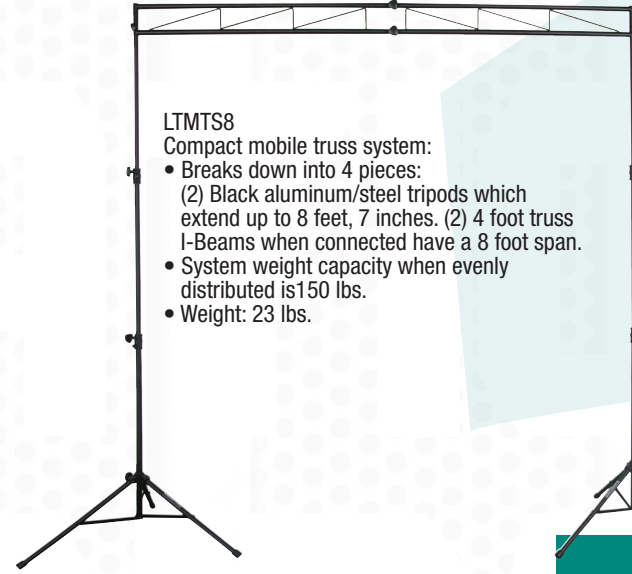

LTMTS8
Compact mobile truss system:

- Breaks down into 4 pieces: (2) Black aluminum/steel tripods which extend up to 8 feet, 7 inches. (2) 4 foot truss I-Beams when connected have a 8 foot span.
- System weight capacity when evenly distributed is 150 lbs.
- Weight: 23 lbs.



Specially designed to carry the LTMTS8 mobile trussing system. Interior Dims: 52.5" x 8" x 7.75"

Odyssey's MTS-8 is an eight feet wide Mobile Truss System. It's made extra compact & light so it's easier on your back and to store, but still strong and high for those essential LED lighting effects for your mobile gigs. A convenient system carry bag, BLTMTS8, is optional.

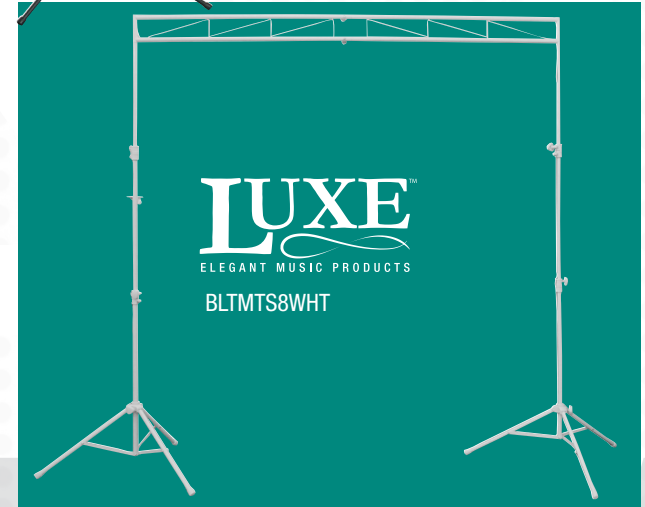

LUXE
ELEGANT MUSIC PRODUCTS
BLTMTS8WHT

SPEAKER STANDS & ACCESSORIES

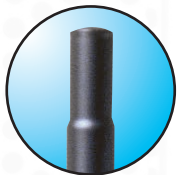

Features a reversible pole with 1 3/8" on one end and 1 1/2" on the other end



LTS2

LTS2 9.5 ft TRIPOD
Black high quality aluminum/steel speaker tripod stand

- Tripod extends to 9.5 ft.
- Folds up for easy transport
- Maximum load capacity 100 lbs.
- Weight: 8.5 lbs.

LTS1 6 ft TRIPOD
Black high quality aluminum/steel speaker tripod stand

- Tripod extends to 6 ft.
- Folds up for easy transport
- Maximum load capacity 100 lbs.
- Weight: 7 lbs.

LATS A1 (OPTIONAL)

LTS1

LTS1A

New to our existing line up of speaker and lighting stands is the LTS1A articulating tripod. Articulating leg stands are the perfect solution for setting up your speaker or lighting rig on uneven surfaces such as steps or sloped surfaces. One leg on each stand is adjustable so you can easily set up your rig without the fear of tipping over. Also available in the all new Luxe™ Stand Series' white finish (LTS1AWHT) and in Pro Crank-up Stand versions in both colors (LTS1APRO & LTS1APROWHT).

OPTIONAL ACCESSORIES



LATS A1



LATS A1WHT



LATS A2



LATS A2WHT



LATS A3

- 1-1/2" in speaker mounting adapters
- Mount to the bottom of a speaker

LATS A1 and Luxe series white LATS A1WHT are used as a mounting platform for speakers, followspot, and select moving head fixtures. This mounting adapter easily slides down on top of most tripod stands. Included are 4 wood screws. 1-3/8" diameter adapter.

SPEAKER STANDS & ACCESSORIES

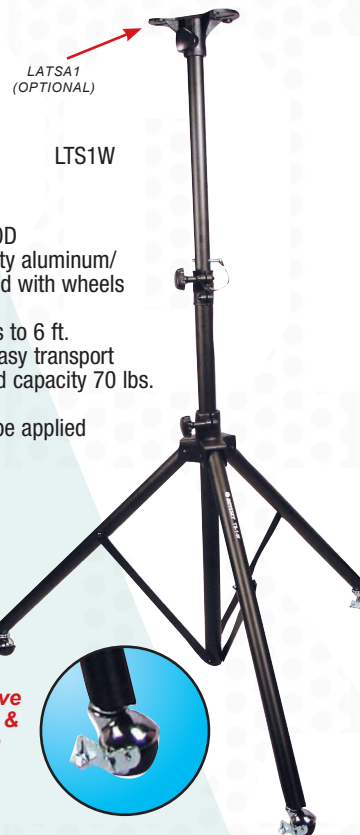

LTS1W

LTS1W 6 ft TRIPOD
Black high quality aluminum/steel tripod stand with wheels and brakes

- Tripod extends to 6 ft.
- Folds up for easy transport
- Maximum load capacity 70 lbs.
- Weight: 7 lbs.
- Brakes must be applied when in use

Exclusive wheels & brake



LTS1AWHT

LTS1WHT

MODEL	WEIGHT	DESCRIPTION:
LTS2	8.5 lbs.	Black high quality aluminum/steel speaker tripod stand
LTS1	7 lbs.	Black high quality aluminum/steel speaker tripod stand
LTS1A	14 lbs.	Black high quality aluminum/steel speaker tripod stand
LTS1AWHT	14 lbs.	White high quality aluminum/steel speaker tripod stand
LTS1W	7 lbs.	Black high quality aluminum/steel tripod stand with wheels and brakes
LTS1WHT	13 lbs.	White high quality aluminum/steel speaker tripod stand

SPEAKER STAND PACK

The LTS2X2B Speaker Stand Pack comes with two Speakers stands and a carrying bag for easy transport. Each stand holds up to 100 pounds evenly distributed and extends to a height of up to 7 feet. The extension pole includes a built-in system that locks at the highest point so you don't have to worry about over extending the pole and causing the mounted speaker to fall. Tripods also feature folding legs and no-slip rubber feet. Pin locks included.

LTS2X2B



FEATURES

- Minimum Height: 3.5 feet
- Maximum Height: 7 feet
- Weight of Two Stands with Bag: 19 lbs.
- Single Stand Weight: 9 lbs.
- Speaker Diameter Pole: 1 3/8"

Carrying Bag Included.



CRANK-UP SPEAKER POLES

SPEAKER CRANK-UP EXTENSION POLE



ASCE42

Approx. 10.25"
Height Adjustment

43.25"
Minimum Height



Tired of short poles that don't get your tops high enough? Scared of mounting your heavy tops on long poles? Never fear, Odyssey is here with our Crank Extension Pole. Put it in your sub, mount your speaker and crank it up!

- Comes with a pole size adaptor
- Weight is 6 lbs.
- Also available in white



LUXE
ELEGANT MUSIC PRODUCTS

ASCE42WHT

CRANK-UP STANDS & ACCESSORIES



LTS1PRO

Speaker Mount optional

CRANK it up!

LTS1PRO

Our super portable speaker stand cranks up to 6' utilizing an ingenious internal gear system. For transporting your tripod system, see our BLTUNI trans-port bag.

- Full cranked height reaches 6'
- Max. Weight Capacity is 80 lbs.(evenly distributed)
- Weights: 16 lbs.

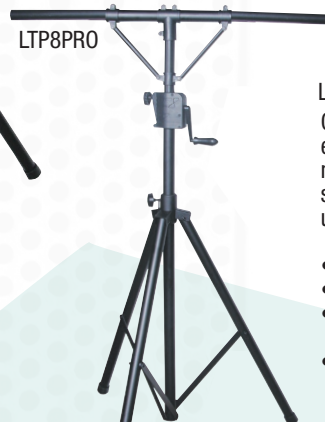

LTP8PRO

LTP8PRO

Our portable crank T-bar makes it that much easier to get your gear up and running in no time. Utilizing an ingenious internal gear system rather than cables makes it safer to use and worry-free for years and years.

- Full cranked height reaches 8.5'
- Top cross bars is 48" long
- Max Weight Capacity is 80 lbs. (evenly distributed)
- Weights: 21 lbs.



LTS1APRO

LTS1APRO

New to our existing line up of speaker and lighting stands is the LTS1APRO articulating crank-up tripod. Articulating leg stands are the perfect solution for setting up your speaker or lighting rig on uneven surfaces such as steps or sloped surfaces. One leg on each stand is adjustable so you can easily set up your rig without the fear of tipping over.

- Full cranked height reaches 8.5'
- Max Weight Capacity is 100 lbs.(evenly distributed)
- Weights: 23 lbs.



LUXE
ELEGANT MUSIC PRODUCTS

LTS1APROWHT

Features an articulating tripod leg



LTMTS1-PRO

Our portable 10' span crank truss system features a revolutionary method to get your lighting up and running in no time. Utilizing an ingenious internal gear system rather than cables that provides a safer, worry free setup.

- Full cranked height reaches 8 1/2 feet
- Can handle an evenly spread load of
- weight: 50 lbs.

TOTE BAG ACCESSORIES



BLTMTS

Specially designed to carry a mobile truss system. Also great for storing other accessories such as tall cymbal stands, mic boom stands, tripods, etc.



BLTUNI

Odyssey Universal Tripod Stand Bag
Dim: 12" x 63.5"
For all Odyssey single tripod stands.
Drawstring closure.



BRLTMTSW

Tote Bag with end wheels on one side and a handle on the other. Roll your mobile system to and from your vehical and gig! Holds up to 100 lbs. max.
Interior Dims: 65" x 9" x 11"

It's time to upgrade your mobile lighting setup with the **NEW** Innovative **ODYSSEY® Halo™ DJ Truss System** **No Time, No Tools, No worries.** ***Sets up in 2 minutes. No kidding!**



*Set up time based only on the required time allotted towards building the Halo DJ Truss system. This does not include any lighting or wiring setup. Individual time may vary. Tighten all knobs to safely secure your Halo™ DJ Truss system.

Lights are for illustration purposes only. Lights are not included.

Patent Pending

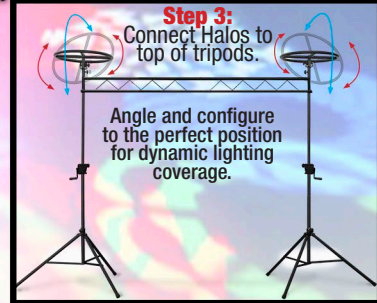
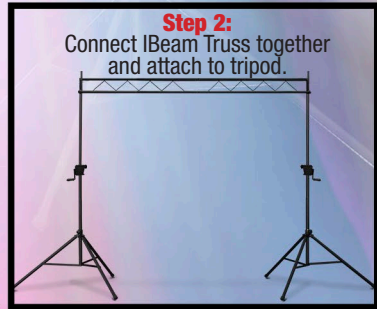

Each systems' Halo' ring structure allows you to create 360 degree lighting arrangements on each end of the 10' I-beam span for a wide range of lighting configuration possibilities that are impossible with just the standard mobile lighting truss setup.

Now if you really want to get 'cranking', the PRO versions crank system can easily raise that lighting rig up to 10 feet high off the ground.

Want more creativity? The PRO versions' Halo Rings also have adjustable joints that can tilt to any angle, even full vertical, adding an extraordinary dimension to your lighting design.

Load capacity is an incredible 300 lbs. evenly distributed. Portability, high stability, and increased setup creativity is what you get with our Halo lighting systems!

HALO DJ TRUSS SYSTEMS

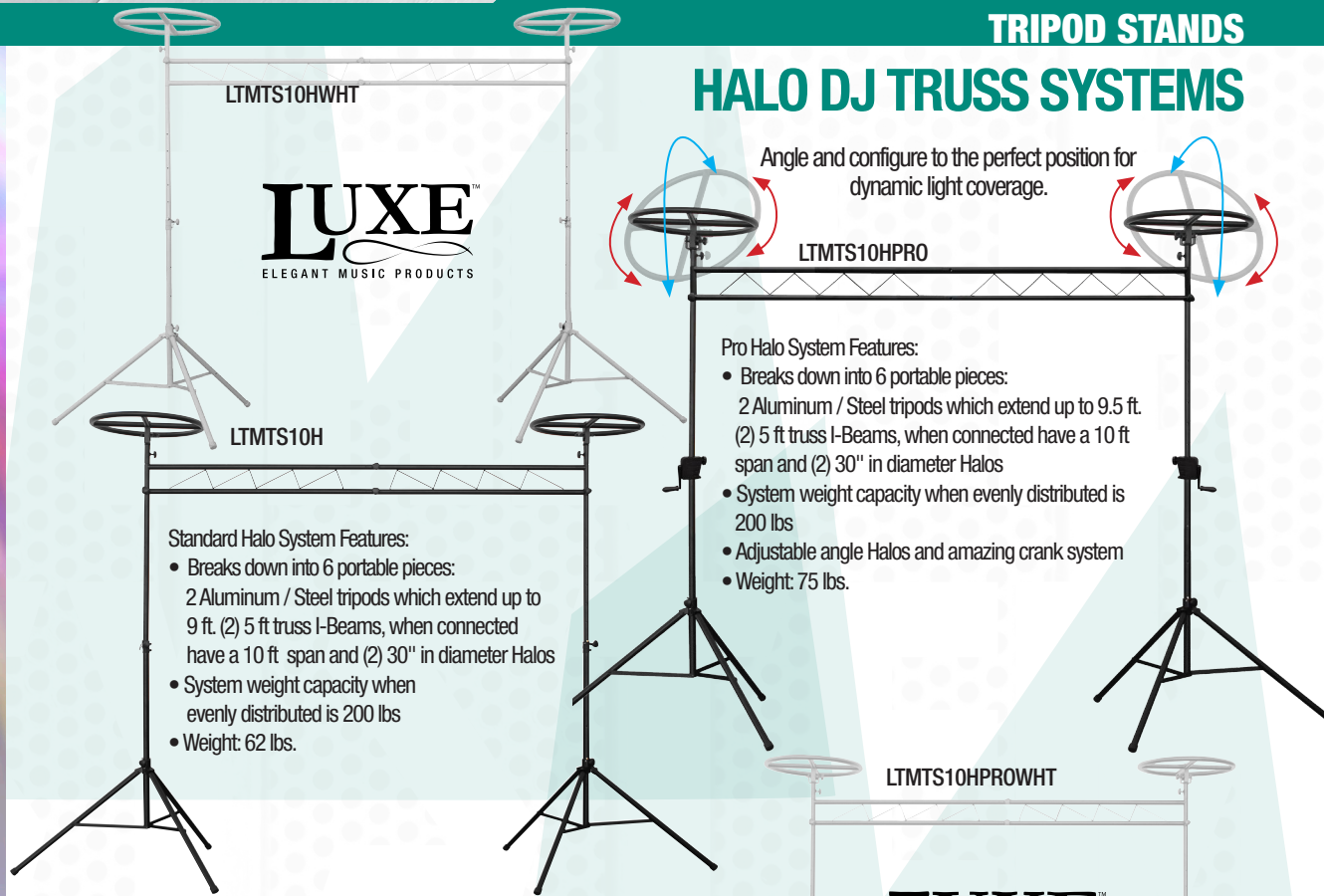

LTMTS10HWHT



LTMTS10H

- Standard Halo System Features:**
- Breaks down into 6 portable pieces:
 - 2 Aluminum / Steel tripods which extend up to 9 ft. (2) 5 ft truss I-Beams, when connected have a 10 ft span and (2) 30" in diameter Halos
 - System weight capacity when evenly distributed is 200 lbs
 - Weight: 62 lbs.

LTMTS10HPRO

- Pro Halo System Features:**
- Breaks down into 6 portable pieces:
 - 2 Aluminum / Steel tripods which extend up to 9.5 ft. (2) 5 ft truss I-Beams, when connected have a 10 ft span and (2) 30" in diameter Halos
 - System weight capacity when evenly distributed is 200 lbs
 - Adjustable angle Halos and amazing crank system
 - Weight: 75 lbs.

LTMTS10HPROHWHT

HALO SYSTEM TOTE BAG ACCESSORIES

BLTMTSHALO
Holds 2 Halos



BLTMTS
Standard Tote Bag

BRLTMTSW

Rolling Tote Bag with end wheels on one side and a handle on the other.



All measurements are approximate. Gear are not included. Designs are subjected to change without notice.

PAR BARN DOORS



LSPAR16W



LSPAR16B



LSPAR20W



LSPAR20B



LSPAR30W



LSPAR30B



LSPAR16

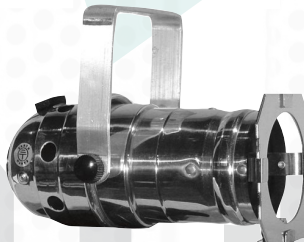

LSPAR20

Odyssey par fixtures are ideal when you want to add that special light decor touch to your setups. It's great for DJ as well as architectural applications to light up tables, back-drops, hallways, etc. Use them with just the right lamps and in combination with other light fixtures to give that perfect color wash effect. Available in high polish aluminum, black and white.

- Aluminum Exterior
- E26/E27 Medium Screw Bulb Base (Standard household base) *(lamp not included)
- Octagonal Gel Frame with Easy Secure Gel Frame Spring Clip
- Includes A/C Cord and 3.5" Hanging Yoke

POLISH ALUMINUM

MODEL	DIMS	WEIGHT
LSPAR16	3.75" X 3.4" X 7.5"	0.75 LBS.
LSPAR20	4" X 4" X 8.25"	0.75 LBS.

BLACK

MODEL	DIMS	WEIGHT
LSPAR16B	3.75" X 3.4" X 7.5"	0.75 LBS.
LSPAR20B	4" X 4" X 8.25"	0.75 LBS.
LSPAR30B	5" X 5" X 10.5"	1.1 LBS.

WHITE

MODEL	DIMS	WEIGHT
LSPAR16W	3.75" X 3.4" X 7.5"	0.75 LBS.
LSPAR20W	4" X 4" X 8.25"	0.75 LBS.
LSPAR30W	5" X 5" X 10.5"	1.1 LBS.

Bulb Not Included



LSPAR16BDB



LSPAR20BDP



LSPAR20BDW

LSPAR barn door apparatuses attach to Odyssey par can light fixtures. Control superfluous spill light from the stage or other architectural projection elements with the adjustable folding frame appendages. Available in various sizes and colors.

- Aluminum Construction
- Adjustable Folding Frame
- For Odyssey Par 16, 20, and 30 Light Fixtures
- Available in Black, Polished Aluminum, and White



POLISH ALUMINUM

MODEL	DESCRIPTION	DIMS	WEIGHT
LSPAR16BDP	Par 16 Barn Door	4.25" X 3.25" X 0.75"	0.50 LBS.
LSPAR20BDP	Par 20 Barn Door	4.25" X 3.5" X 0.75"	0.35 LBS.

BLACK

MODEL	DESCRIPTION	DIMS	WEIGHT
LSPAR16BDB	Par 16 Barn Door	4.25" X 3.25" X 0.75"	0.50 LBS.
LSPAR20BDB	Par 20 Barn Door	4.25" X 3.5" X 0.75"	0.35 LBS.
LSPAR30BDB	Par 30 Barn Door	6.25" X 5.75" X 0.75"	0.75 LBS.

WHITE

MODEL	DESCRIPTION	DIMS	WEIGHT
LSPAR16BDW	Par 16 Barn Door	4.25" X 3.25" X 0.75"	0.50 LBS.
LSPAR20BDW	Par 20 Barn Door	4.25" X 3.5" X 0.75"	0.35 LBS.
LSPAR30BDW	Par 30 Barn Door	6.25" X 5.75" X 0.75"	0.75 LBS.

*Par light fixture sold separately

C-CLAMPS



- LAC28**
- Working load limit is 220 lbs. (100kg.)
 - Compatible with 1.25"-2" (32-51mm) Tubes
 - 1.1" (28mm) Thick

MEDIUM-DUTY CLAMPS



- LACMS30 / LACMS30B**
HEX BOLT with Standard Wing Nut
- Working load limit is 165 lbs. (75 kg)
 - Compatible with 1.5"-2" (48-51mm) Tubes
 - 1.18" (30mm) Thick



- LACML30 / LACML30B**
HEX BOLT with Large Wing Nut
- Working load limit is 165 lbs. (75 kg)
 - Compatible with 1.5"-2" (48-51mm) Tubes
 - 1.18" (30mm) Thick

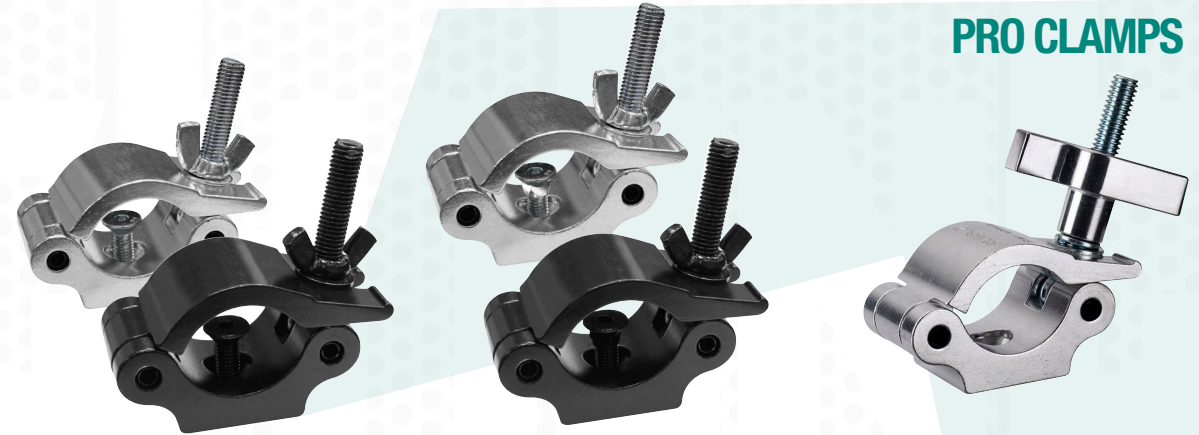

- LACP50R / LACP50RB**
Wide with Round Neck
Countersunk Bolt
- Working load limit is 1,102 lbs. (500 kg.)
 - Compatible with 1.5"-2" (38-51mm) Tubes

- LACP50S / LACP50SB**
Wide with Squared Neck
Countersunk Bolt
- Working load limit is 1,102 lbs. (500 kg.)
 - Compatible with 1.5"-2" (38-51mm) Tubes
 - 2" (50mm) Thick

- LACP50LB**
Wide with Large Wing Nut
- Working load limit is 1,102 lbs. (500 kg.)
 - Compatible with 1.5"-2" (38-51mm) Tubes
 - 2" (50mm) Thick



- LACP / LACPB**
- Working load limit is 661 lbs. (300kg.)
 - Compatible with 1.25"-2" (32-51mm) Tubes

QUICK RIG PRO CLAMPS



- LACQ30 / LACQ30B**
- Wrap-around Hook Design
 - Working Load Limit is 330 lbs. (150 kg.)
 - Compatible with 1.5"-2" (38-51mm) Tubes
 - 1.18" (30mm) Thick

TRIGGER PRO CLAMPS



- LACT28 / LACT28B**
- Heavy-Duty Hook Design
 - Working Load Limit is 330 lbs. (150 kg.)
 - Compatible with 1.5"-2" (38-51mm) Tubes
 - 1.1" (28mm) Thick



- LACP30R / LACP30RB**
Narrow with Round Neck
Countersunk Bolt
- Working load limit is 661 lbs. (500 kg.)
 - Compatible with 1.5"-2" (38-51mm) Tubes
 - 1.18" (30mm) Thick



- LACP30S / LACP30SB**
Narrow with Squared Neck
Countersunk Bolt
- Working load limit is 661 lbs. (500 kg.)
 - Compatible with 1.5"-2" (38-51mm) Tubes
 - 1.18" (30mm) Thick

EYE BOLT PRO CLAMPS



LACPE50 / LACPE50B

- Wide with Eye Bolt
- Working Load Limit is 1102 lbs.(500 kg.)
 - Compatible with 1.5"-2"(38-51mm) Tubes
 - 2"(50mm)Thick



LACPE30 / LACPE30B

- Narrow with Eye Bolt
- Working Load Limit is 661 lbs.(300 kg.)
 - Compatible with 1.5"-2"(38-51mm) Tubes
 - 1.18"(30mm)Thick

DUAL SWIVEL PRO CLAMPS



LACSDP50 / LACSDP50B

- Wide Dual Swivel
- Working Load Limit is 1,102 lbs.(500 kg.)
 - Compatible with 1.5"-2"(38-51mm) Tubes
 - 2"(50mm)Thick



LACSDP30 / LACSDP30B

- Narrow Dual Swivel
- Working Load Limit is 661 lbs.(300 kg.)
 - Compatible with 1.5"-2"(38-51mm) Tubes
 - 1.18"(30mm)Thick

ODY SHIELDS

"A FINISHING TOUCH OF ELEGANCE"

Are you looking for a way to add a finishing touch of elegance to your uplighting packages? Well the Solution is here with our new UpLighting Décor Ody Shields from Odyssey Innovative Designs.

Ody Shields are Uplighting covers designed not only to conceal your Uplight fixtures while in use but also to give them limited protection from being stepped on or kicked. Ody Shields are made of 1/8" white acrylic material that is light weight, durable, easy to transport and most important, transparent so that when in use you will get a constant beam of light from floor to ceiling without the dark gap you get from other shields.

Many event facilities now require all up-lighting fixtures to be covered up with some type of barrier so that they don't become trip hazards, or take away the elegant look from other décor in the room. Our standard shields come in two sizes, 15" and 20".

The 15" Shield is ideal for battery powered led fixtures, and will accommodate both 56 and 64 LED fixtures. The 20" Shield will work great with virtually any round shaped led lighting fixture or even a smaller footprint par can; being that it's taller it will also conceal the Edison connector and wall receptacle so that there is no visible cords. Also as an option the Ody Shields thermo formed panels can be custom trimmed to a desired height.



ODYSHLD2008WHT
12"W x 20"H x 6"D



ODYSHLD15088BLK
12"W x 15"H x 6"D



ODYSHLD2008BLK
12"W x 20"H x 6"D

*Sold in sets of 8 shields. Case included for a limited time only.



BEFORE

AFTER

VSS™ MOBILE VIDEO SCREEN SYSTEMS

Whether your next gig is big or small, you want your video show to be as dramatic and memorable as possible. The best way to enhance the “total experience” of your video display is with our Mobile VSSL™ video screen system. The VSSL™ systems boasts maximum image quality and luminosity indoors or outdoors and features front or rear projection. At the maximum stretched point the viewing field is 88” x 60”. At the minimum stretched point the viewing field is 80” x 52”.

- Max Height is 14'
- Min Height is 6'
- Max Width 10'5"
- Min Width is 8'
- Includes Tripod Frame, Video Screen, Lower Bar Tripod attachment & Carrying Bag
- 55 lbs. with bag
- Video screen (LTMVSCREEN3) & dual tripod frame also sold separately



The entire Mobile VSSL™ system, including the screen, fits into its durable heavy-duty bag, ready for travel or storage.

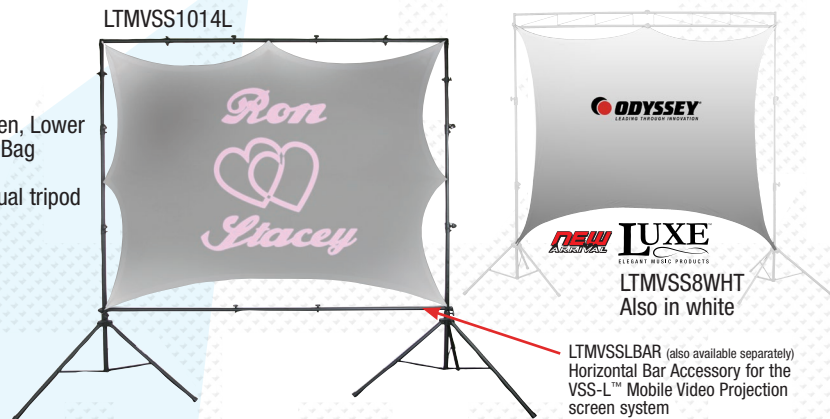

The Odyssey VSS-8 Mobile Video Screen System is a convenient projection screen display package consisting of one MTS8 Mobile Truss System (LTMTS8) and one Scrim Werks™ 7' x 5' Projection Stretch Screen (LTMVSCREEN3). Made extra compact & light, it's easy on your back and to store, but still strong and high enough for those essential LED lighting effects for your mobile gig as well as the LTMVSCREEN3 projection stretch screen*. So simple to set up, it can be done in less than 3 minutes. Just attach the two 4' truss sections together and place on top of the tripods (tighten tension knobs as you go). Then attach the screen loops to the frame knobs, raise the bars to the maximum height, secure, and you're done!

- Front and Rear Projection Screen
- 6'8" x 5' Viewing Field
- Screen made of High Quality Lycra Spandex
- Flame Retardant Treated Screen
- * (Retardant must be retreated after washing or dry cleaning)
- Carry Pouch and Attachment Straps For Screen Included
- Max Height is 8'7", Width 8'
- MTS8 Frame Can Handle an Evenly Spread Load of 150 lbs.

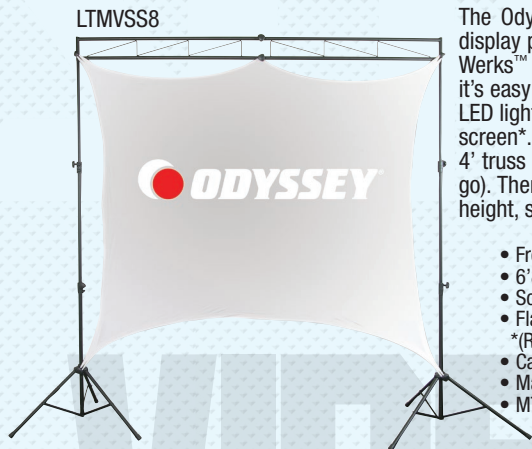

VSS-1RT RAISE AND TILT MOBILE VIDEO SCREEN SYSTEM

The VSS-1RT™ system's unique screen frame “Raise and Tilt” feature allows for extra setup diversity and also features front or rear projection. At the maximum stretched point the viewing field is 88” x 60”. At the minimum stretched point the viewing field is 84” x 63”.

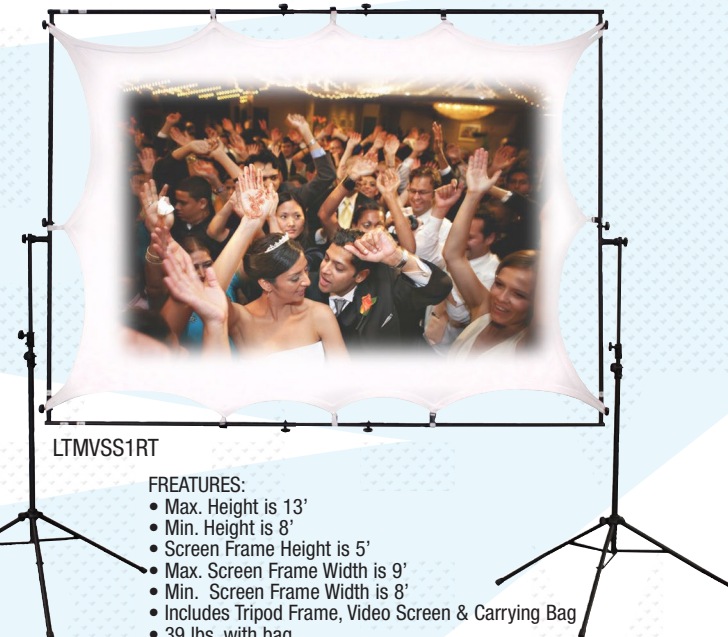
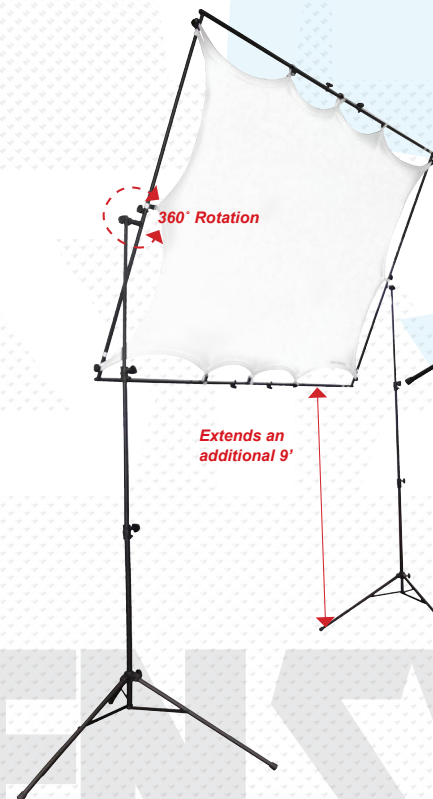

The entire Mobile VSS-1RT™ system, including the screen, fits into its durable heavy-duty bag, ready for travel or storage.





VIDEO PROJECTION STRETCH SCREENS

Odyssey Scrim Werks™ projection screens can be used for a wide variety of applications from unique outdoor shading decor configurations attached onto truss or other temporary structures to indoor theatrical or banquet backdrops and projection. Each has sewn in loop points to secure and stretch into various shapes and sizes. Use in conjunction with other Scrim Werks™ products along with colored light washes or small silhouette projections to achieve that extra ambiance to your scrim design.* Carry pouch and attachment straps included.

**(Use all necessary precautions when using with heat and electrical related devices.)*



LTMVSCRNSM

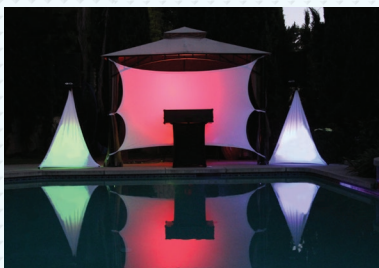

LTMVSCREEN3 used in conjunction with SPATRI4WHT Tripod Scrims



LTMVSCREEN3
*24 attachment loops
Frame is optional

X STAND SLIP SCREENS™

Dress up your LTBXS X Stand with Odyssey's SPALTBXS Slip Screen™ covers available in white or black. The SPALTBXS stretches snugly over the top of the X Stand down to the 4 leg points projecting a clean professional look to your set up by keeping your cables hidden from your audience. For attention grabbing light decor use the white Slip Screen™ in conjunction with a small LED color wash effect underneath.*

**(Use all necessary precautions when using with heat and electrical related devices.)*



SPALTBXSWHT



SPALTBXSBLK

FEATURES:

- Hassle Free Set-up
- Material Recovers to Original State After Being Stretched
- Flame Retardant Treated
- Reinforced X Stand Leg Pockets
- Machine Washable *(flame retardant must be retreated after washing)
- Carry Pouch Included
- Exterior Dimensions In Carrying Pouch: 3.5" x 11.5" x 3"



carrying pouch included



PROJECTION SCREENS VIEWING FIELDS	MAX. VIEWING FIELD	IN. VIEWING FIELD
LTMVSCREEN3	98" x 62"	86" x 53" *24 attachment loops
LTMVSCRNSM	72" x 30"	60" x 24" *can also be used with tripod light stands

**(Use all necessary precautions when using with heat and electrical related devices.)*

**LIGHT COLUMNS™
PATENT PENDING**

Create clean and dramatic lighting effects with Odyssey's Scrim Werks™ Light Columns™. With 1'-10' high available sizes, they're perfect for enhancing event décor without using a heavy, bulky, and expensive square truss setup. Extremely lightweight and sturdy, with Scrim Werks™ Light Columns storage and transport space is not an issue. Each comes with 4 individual aluminum tubes that attach to a top and bottom aluminum plate with a scrim sleeve matching in length included. Easy to setup and tear down, each column stands strong, erect to impress, and secure to place a moving head light on top, yet conveniently compact when in storage.

Lighting not included.



Odyssey Innovative Designs is also known as ODY-USA. ODYUSA. Odyssey is an industry-leading designer and manufacturer of professional mobile accessory solutions for the DJ, musical instruments, and pro audio markets. Founded in 1995, Odyssey has brought to market hundreds of unique products and continues to lead the industry with innovative patented products. With numerous technology and design awards, Odyssey has established a worldwide reputation for innovation, quality and design. The Odyssey group of companies includes **Show Solutions** and **BC Cases**.



809 West Santa Anita Street San Gabriel, CA 91776 Tel: 626.588.2528 • Fax: 626.588.2525 • www.OdysseyGear.com

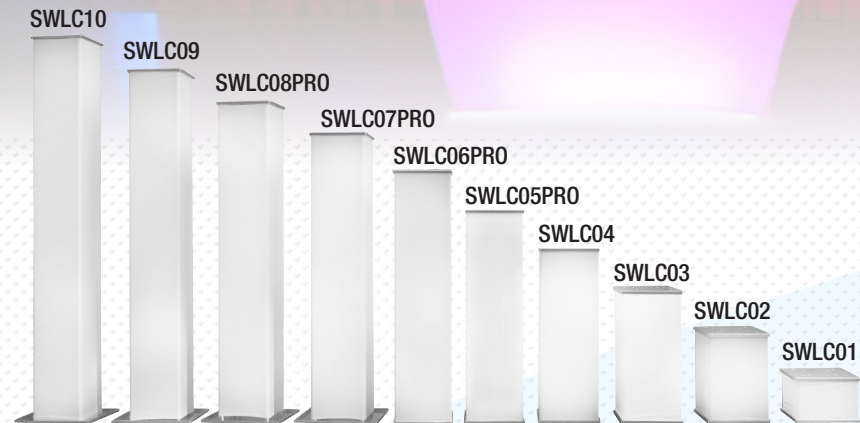
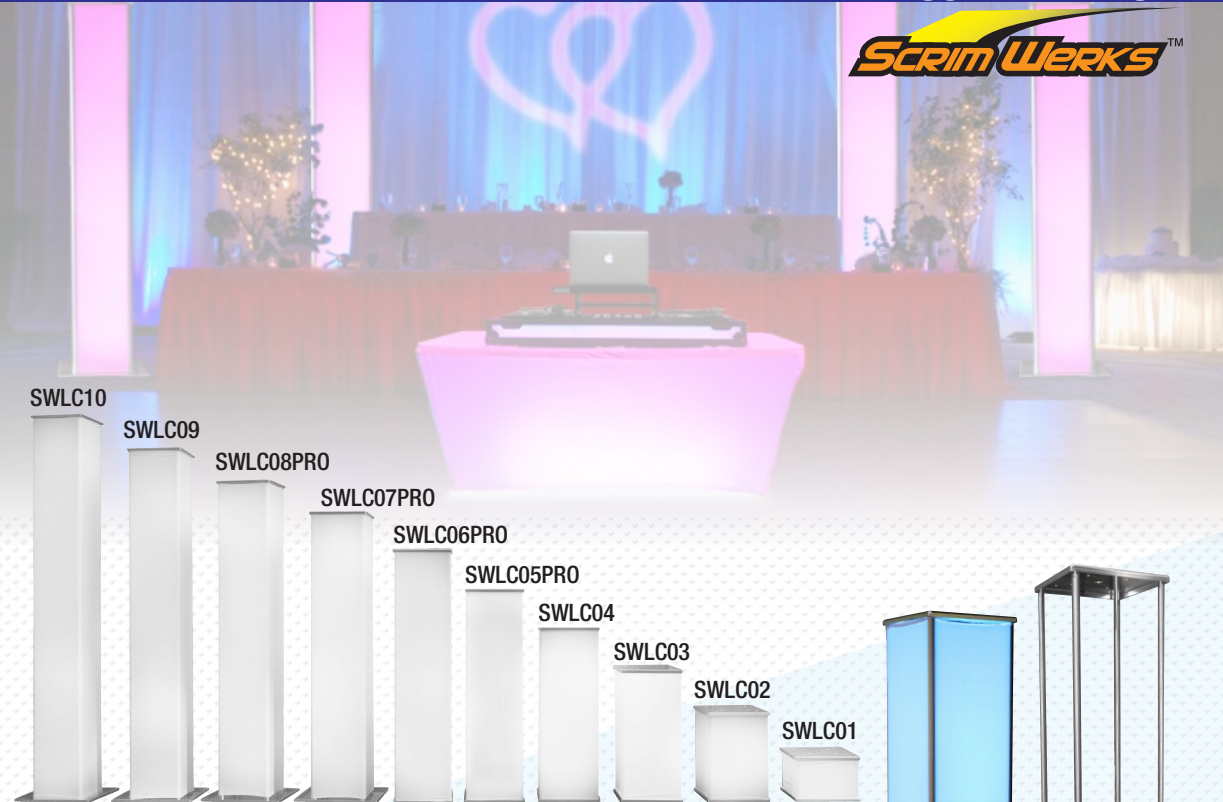

Suggested Light Column support weight - 40 lbs.

MODEL	HEIGHT	WEIGHT	Base Plate
SWLC01	1'	18 lbs.	17"
SWLC02	2'	20 lbs.	17"
SWLC03	3'	22 lbs.	17"
SWLC04	4'	23 lbs.	17"
SWLC05PRO	5'	26 lbs.	17"
SWLC06PRO	6'	27 lbs.	17"
SWLC07PRO	7'	44 lbs.	24"
SWLC08PRO	8'	47 lbs.	24"
SWLC09	9'	50 lbs.	24"
SWLC10	10'	52 lbs.	24"

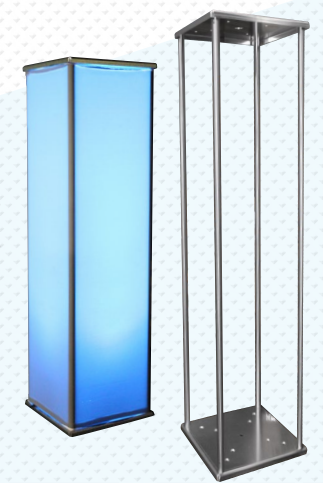

Scrim Werks™ LIGHT COLUMN BASE PLATES



17" x 17"

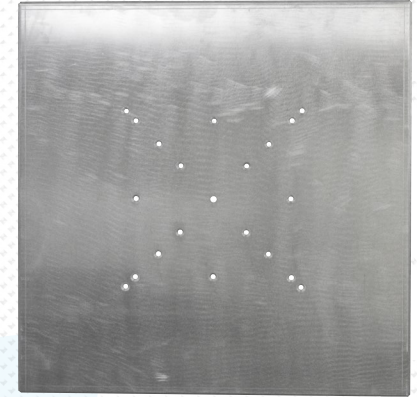

36" x 36"

Model	Size
SWLCBP17	17" x 17"
SWLCBP24	24" x 24"
SWLCBP30	30" x 30"
SWLCBP36	36" x 36"

LIGHT COLUMN CARRYING BAGS



BSWLCB24
Holds up to two light column plates up to 24" x 24" or smaller



BSWLCPO2
Holds up to 2 feet long light columns poles



BLTMTS8
Holds up to 4 feet long light columns poles



BSWLCPO3
Holds up to 3 feet long light columns poles

LIGHT COLUMN SPEAKER STUD ADAPTOR

Introduce more diversity to your special event set-ups. Secure your speakers by mounting them on top of Odyssey Scrim Werks™ Light Columns with the convenient SWLCSPKSTUD Light Column Speaker Stud. It easily attaches to the plate of any one of the 1' to 10' high columns. Just another way to elevate your decor as well as your speakers.

SWLCSPKSTUD



- Features and Specs.**
- 1-3/8" Diameter
 - 3" High Stud
 - High Grade Aluminum Construction
 - Includes Mounting Wing Nut Bolt For Easy Set-Up
 - Fits All Odyssey "SWLC" Scrim Werks™ Light Column Plates

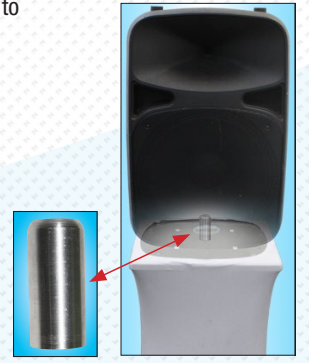

12" MOLDED SPEAKER COVER SLIP SCREENS™



SWSPKWHT



SWSPKBLK

Dress up your speakers with Odyssey's Scrim Werks™ Slip Screen™ covers. Simple and easy to use, they stretch snugly over the top of many popular 12" molded speaker brands projecting a clean professional look to your set up. They also fit smaller size 15" molded speakers and larger size 10" molded speakers. Available in white or black colors.

- Features and Specs:**
- Fits Many Popular Small and Medium Size 12" Molded Speakers
 - Also Fits Many Smaller Size 15" Molded Speakers and Larger Size 10" Molded Speakers
 - Bottom Tension Draw String
 - Material Recovers to Original State After Being Stretched
 - Flame Retardant Treated
 - Carry Pouch Included
 - Unstretched dimensions: Back Width 15", Height 27", Center Front to Back 7.75"

SCRIM WERKS™ TRUSS SLEEVES SLIP SCREENS™

Presentation is everything to your audience, so when you want to add that extra nice décor to your set up, use Odyssey's new Scrim Werks™ Slip Screens™. Slip them over dull or scratched up truss and transform them into clean white columns or illuminate them in glowing majestic colors with an LED light washes. Use in conjunction with other Scrim Werks™ product to create a great background effect and percolate structural ambiance to any outdoor or indoor banquet, rave, or theatrical setting.

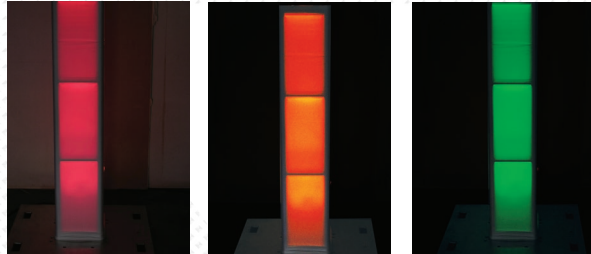

Fits standard 12" x 12" square truss sticks
Available in 3 lengths without zippers

- TS1205 for 5' long truss
- TS1208 for 8' long truss
- TS1210 for 10' long truss

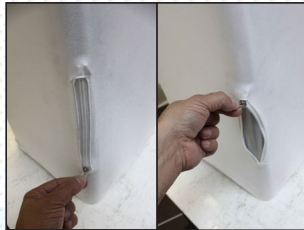

*truss zipper scrims

Access Series II Black Pro Slip Screen™ Truss Scrims
Available in 3 lengths



TS1205

TS1210

TS1206CZBLK
6' Long

TS1208CZBLK
8' Long

TS1210CZBLK
10' Long

Standard Truss Zipper Slip Screen™ Scrims
Available in 4 lengths

- TSZ1203 for 3' long truss
- TSZ1205 for 5' long truss
- TSZ1208 for 8' long truss
- TSZ1210 for 10' long truss

Access Series II Pro Slip Screen™ Truss Scrims
Available in 7 lengths

- TS1202CZ for 2' long truss
- TS1203CZ for 3' long truss
- TS1204CZ for 4' long truss
- TS1205CZ for 5' long truss
- TS1206CZ for 6' long truss
- TS1208CZ for 8' long truss
- TS1210CZ for 10' long truss

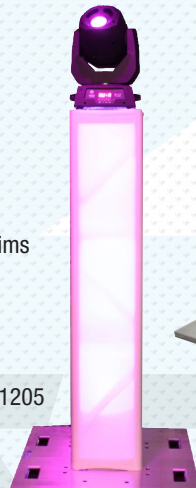

*truss and lighting effects not included

SCRIM WERKS™ PRO DJ FACADES

Today's special event DJs continue to step-up their game with more elaborate clean setups. Odyssey Scrim Werks™ DJ facades are ideal accessories for these entertainers. Each consists of four detachable pin-hinged sections consisting of a super lightweight, powder coated aluminum frame. Have a larger than usual setup? You can combine the sections from multiple sets of the same height to create a wider facade if needed. The black dual layer scrim faces are fire retardant treated and can be used in conjunction with lighting effects to create that perfect look for any momentous occasion. After the gig, if you find a stain on the scrim from an accidental drink spill or other mishap, no problem. All that is required is a screw driver to simply remove the scrim for cleaning.

SWFTT5816B*



SWF4846B*

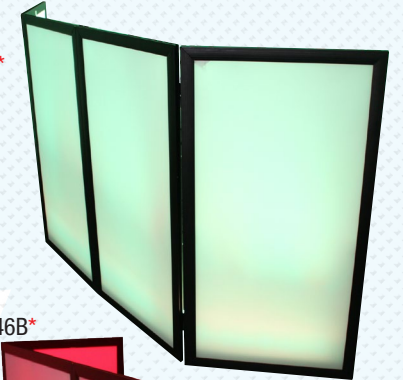

SWF9646B*

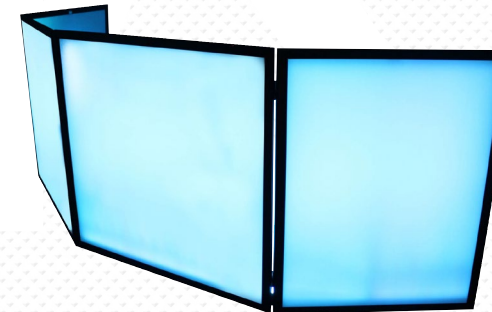

SWF7246B*

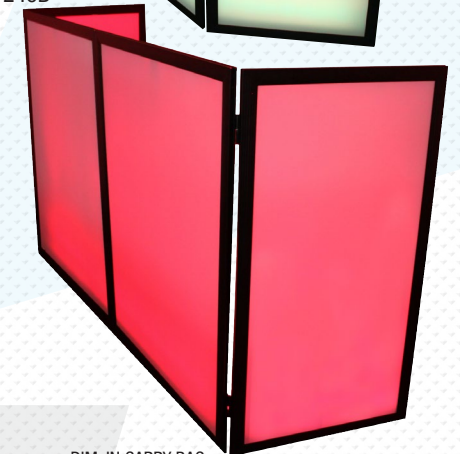

*Screens shown with lighting effects, actual color is white

MODEL	DESCRIPTION	SECTIONS	DIM. IN CARRY BAG
SWF4846B	Floor Facade	(4) 24"W x 46"H	46.75"W x 25"H x 4.25
SWF7246B	Floor Facade	(2) 36"W x 46"H, (2) 24"W x 46"H	48"W x 37"H x 4.25"D
SWF9646B	Floor Facade	(2) 48"W x 46"H, (2) 36"W x 46"H	48"W x 49"H x 4.25"D
SWFTT5816B	Table Top Facade	(2) 29"W x 16"H, (2) 20"W x 16"H	31"W x 17"H x 4.25"D

SCRIM WERKS™ PRO DJ FACADE CENTER ADD-ON PANELS

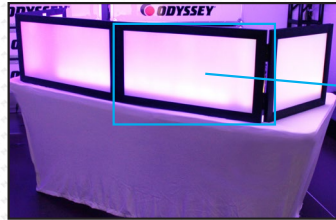

SWFTT5816B Facade shown above

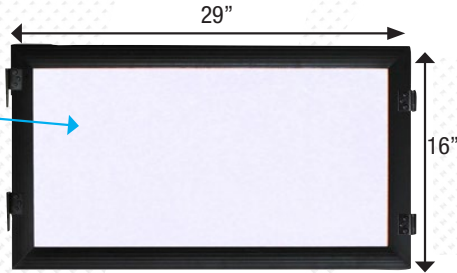

SWTT2916B-2



SWF7246B Facade shown above

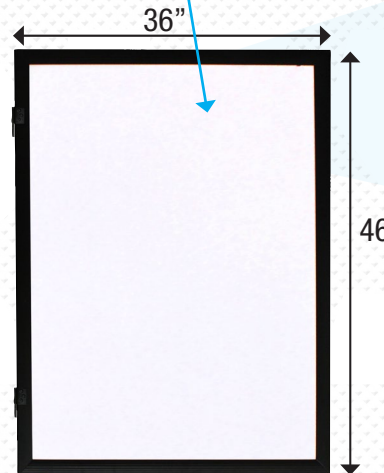

SWF3646B-2(RP)

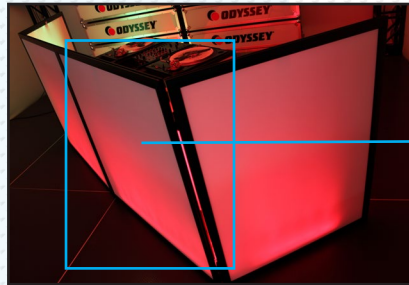

SWF9646B Facade shown above

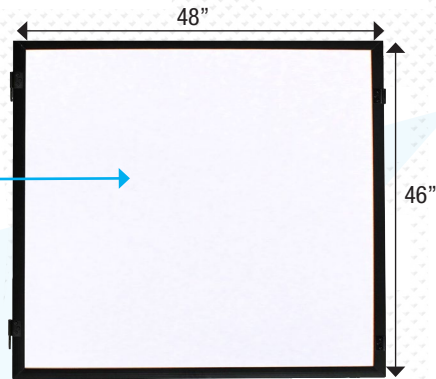

SWF4846B-2RP

add optional center panel sections of the same height to create a wider facade



Need a wider DJ Facade to cover your rig? Increase the length of your Scrim Werks™ DJ facade with one or more of these add-on panels. The convenient connecting-hinges allows for easy setup and tear down, and each is constructed to fit and match perfectly with your existing Scrim Werks™ high facade panels of the same height.

FEATURES:

- Super Lightweight Black Powder Coated Aluminum Frame Construction
- Easy Set-up and Tear-down
- Fire Retardant Treated
- Dual Scrim Screen Face

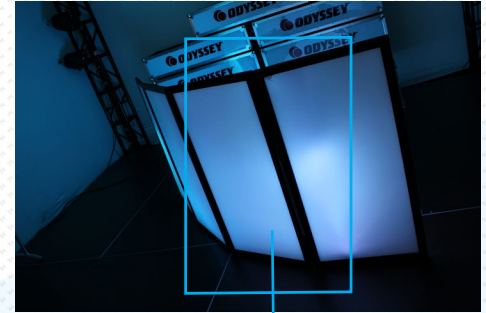

SWF2446B-2(RP) Facade shown above



SWF2446B-2(RP)

MODEL #	DESCRIPTION	WEIGHT
SWF2446B-2RP	24"W x 46"H Center Facade section	8 lbs.
SWF3646B-2*(RP)	36"W x 46"H Center Facade section	9 lbs.
SWF4846B-2*(RP)	48"W x 46"H Center Facade section	11 lbs.

**RP models are for "removable pin" hinged facades



ALL BLACK & ALL WHITE PRO DJ FACADES

You'll love our Scrim Werks™ lineup of All Black and All White scrim facades. We made the aluminum frame trim and scrim colors match for a super slick all black and a super sophisticated all white look. All scrim facades come complete with 4 easy to put together lightweight, aluminum framed panels; two center and one on each side. Assembly is quick and simple with our unique removable L-pin system. No special event DJ rig should be without a Scrim Werks™ DJ Façade from Odyssey.



SWF7246WHT



SWF4846WHT



SWF7246BLK



SWF4846BLK

MODEL #	DESCRIPTION	SECTIONS	DIM. IN CARRY BAG
SWF4846BLK	48" wide, 46" high all-black facade	(4) 24"W x 46"H	46.75"W x 25"H x 4.25"D
SWF4846WHT	48" wide, 46" high all-white facade	(4) 24"W x 46"H	46.75"W x 25"H x 4.25"D
SWF7246BLK	72" wide, 46" high all-black facade	(2) 36"W x 46"H, (2) 24"W x 46"H	48"W x 37"H x 4.25"D
SWF7246WHT	72" wide, 46" high all-white facade	(2) 36"W x 46"H, (2) 24"W x 46"H	48"W x 37"H x 4.25"D



DECOR PANELS

Odyssey's Decor Panels are a great way to help you create attractive and innovative display applications for DJ booth or stage backdrops. With various available shapes and sizes your possibilities are endless. For a complete effect we recommend that panels are used in conjunction with LED lighting or gobo projection lighting.

DECOR PANEL PACKAGES

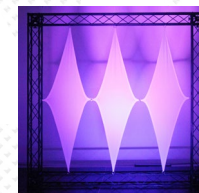

SWDD4819WHTX3

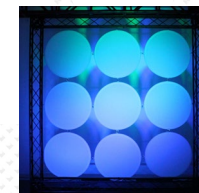

SWDC22WHTX9

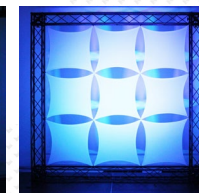

SWDS18WHTX9

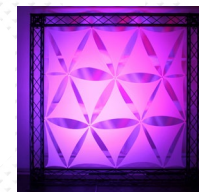

SWDT19WHT



SWDS12WHT

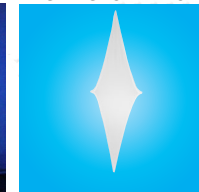

SWDD4819WHT

*Lighting effects are not included

PANEL PACKAGE MODELS	DESCRIPTION	TOTAL PANELS
SWDC22WHTX9	22" DIAMETER WHITE CIRCLE PANELS	9 PCS.
SWDD4819WHT	48" x 19" WHITE DIAMOND PANEL	1 PC.
SWDD4819WHTX3	48" x 19" WHITE DIAMOND PANELS	3 PCS.
SWDS12WHT	12" x 12" WHITE DIAMOND (DIAGONAL SQUARE) PANELS	21 pcs. (10 full panels, 9 half panels, 2 quarter panels)
SWDS18WHTX9	18" x 18" WHITE SQUARE PANELS	9 PCS.
SWDT19WHT	19" EQUILATERAL WHITE TRIANGLE PANELS	21 PCS. (15 full panels, 6 half panels)

NEXUS TRUSS FRAME PACKAGE MODELS	DESCRIPTION	COLOR
NEX15180SWDBLK	DECOR PANEL DISPLAY FRAME, 17"x17" INTERNAL DIMS.	BLACK
NEX15180SWDWHT	DECOR PANEL DISPLAY FRAME, 17"x17" INTERNAL DIMS.	WHITE

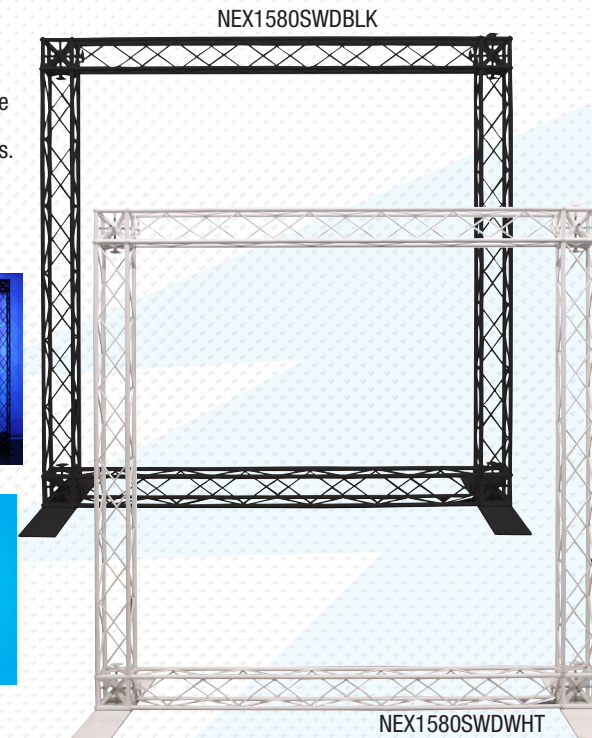



TRIPOD AND TRIANGULAR SCRIMS

The Odyssey Scim Werks™ tripod and triangular scrims are designed to have a variety of functional and decorative uses. For mobile DJ set-ups, use them on your speaker lighting stands for a cleaner and more professional look. They can also be used for a wide variety of applications such as temporary outdoor shading designs with multiple pieces or in conjunction with other Scrim Werks™ screen products. Other popular applications include indoor designs for theatrical or banquet backdrops with small silhouette projections or color wash lighting effects.*

**(Use all necessary precautions when using with heat and electrical related devices.)*



- FEATURES:**
- Made of High Quality Lycra Spandex
 - Material Recovers to Original State After Being Stretched
 - Flame Retardant Treated
 - Machine Washable *(flame retardant must be retreated after washing)
 - Carry Pouch and Attachment Straps Included

SPATRI4WHT scrims used in conjunction with a LTMVSCREEN3

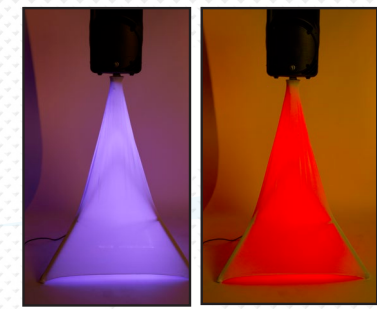

**LIGHTING EFFECTS AND STAND NOT INCLUDED*



TRIPOD SCRIMS			
MODEL	MAX. STRETCH POINT	MIN. STRETCH POINT	SHAPE
LTMVSCRNSM	72" x 30"	60" x 24"	Single Rectangular Section
SWTP3*	52" x 68"	43" x 53"	Two Triangular Sections
SWTP5BLK	72" x 110"	56" x 84"	Two Triangular Sections
SWTP3BLK	52" x 68"	43" x 53"	Single Triangular Section
SPATRI5*	84" x 120"	48" x 80"	Single Triangular Section
SWLTPS*	60" x 80"	42" x 60"	360° Tripod Scrim
LARGE TRIANGULAR SCRIMS			
SWT6088*	15' x 13'	13' x 10'	Single Triangular Section

**available in black(BLK) or white(WHT)*



15' HIGH CRANK STAND SLIP SCREEN™

Dress up any standard 15' high truss crank stand with a Scrim Werks™ SPACS15 black or white Slip Screen™ cover. Just use the scrim buckle straps to secure one to the the top truss support bar, crank the stand up to 15' high, and then bring the cover down fitting the base pockets around the ends of the 3 leg supports. In no time at all your crank setup has been transformed into an elegant clean professional light display support keeping cables as well as the crank hidden from your audience. For attention grabbing light decor, use the "white" Slip Screen™ in conjunction with a LED color wash effect underneath.*

**(Use all necessary precautions when using with heat and electrical related devices.)*

FEATURES:

- Material Recovers to Original State After Being Stretched
- Flame Retardant Treated*
- Reinforced Support Leg Pockets
- Machine Washable

**(flame retardant must be retreated after washing)*



SPACS15BLK

SPACS15WHT

15' HIGH CRANK SCRIMS

MODEL

SPACS15*

* black or white

MAX. STETCH POINT

15'

MIN. STRETCH POINT

10'



TABLE SLIP SCREEN™ COVERS



features convenient top holes for clear cabling (non-print versions only)

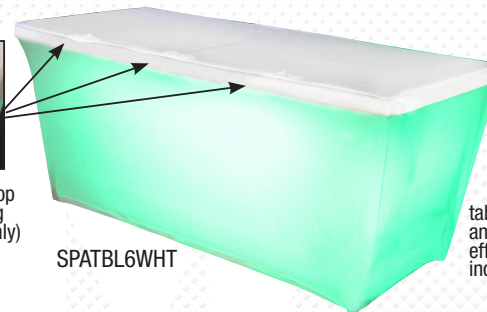

SPATBL6WHT

table, gear, and lighting effect not included



SPATBL4WHT

Hidden rear view



SPATBL4BLK

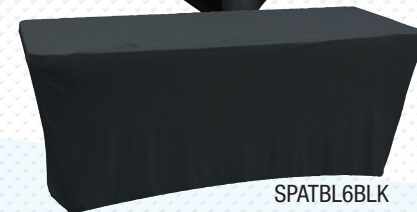

SPATBL6BLK

Dress any standard 4' and 6' banquet table with Scrim Werks™ black or white Slip Screen™ covers. Simple and easy to use, they stretch snugly over the top of the table down to the 4 leg points projecting a clean professional look to your set up by keeping your cables, gear and other items hidden from your audience. Each features multiple holes strategically positioned near the top edge of the table enabling discreet cabling for your table set-up. For attention grabbing light decor, use the white Slip Screen™ in conjunction with a LED color wash effect underneath*.

**(Use all necessary precautions when using with heat and electrical related devices.)*

SPATBL4WHT



FEATURES:

- Hassle Free Set-up
- Material Recovers to Original State After Being Stretched
- Flame Retardant Treated*
- Reinforced Table Leg Pockets
- Machine Washable

**(flame retardant must be retreated after washing)*



SPATBL6002PT
Photo Booth Props Table Cover



SPATBL6001CP
Custom Print Cover

MODEL	DESCRIPTION	FITS
SPATBL4BLK	Black	Standard 4' Long Banquet Tables
SPATBL4WHT	White	Standard 4' Long Banquet Tables
SPATBL6BLK	Black	Standard 6' Long Banquet Tables
SPATBL6WHT	White	Standard 6' Long Banquet Tables
NEW SPATBL6001CP	White with custom print	Standard 6' Long Banquet Tables
NEW SPATBL6002PT	White with custom photo booth props print	Standard 6' Long Banquet Tables

PHOTO BOOTH PRINTER CASES AND BAG



FZHIT520BL



FZHITIP510HW



FZSINFONIACS2



FZDNPRX1



FZMITD70



FZDNPDS40BL



FZPRINTER1HW



BRLUT1HW

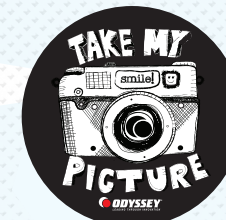

PRINTER CASES

MODEL	DIMENSIONS	WEIGHT	FITS
FZDNP620	15.75" x 14.5" x 18.5"	16 lbs	DNP DP-DS620 photo printer
FZDNP620BL	15.75" x 14.5" x 18.5"	16 lbs	DNP DP-DS620 photo printer
FZDNPDS40	15.75" x 10" x 19"	17 lbs	DNP DS40 / DS80 photo printer
FZDNPDS40BL	15.75" x 10" x 19"	17 lbs	DNP DS40 / DS80 photo printer
FZDNPDS40WHT	15.75" x 10" x 19"	17 lbs	DNP DS40 / DS80 photo printer
FZDNPRX1	14" x 10.25" x 19"	19 lbs	DNP DS-RX1 dye sublimation printer
FZDNPRX1BL	14" x 10.25" x 19"	19 lbs	DNP DS-RX1 dye sublimation printer
FZHIT520	14" x 10.25" x 19"	19 lbs	HITI P520L photo printer
FZHIT520BL	14" x 10.25" x 19"	19 lbs	HITI P520L photo printer
FZHITIP510HW	22" x 16.75" x 18"	32 lbs	HITI P510 photo printer
FZMITD70	17" x 10.5" x 22.5"	17 lbs	Mitsubishi CP-D70DW photo printer
FZMITD70BL	17" x 10.5" x 22.5"	17 lbs	Mitsubishi CP-D70DW photo printer
FZSINFONIACS2	14" x 10.5" x 21.25"	17 lbs	Sinfonia CS2 / Shinko Color Stream CS2 printer
FZSINFONIACS2BL	14" x 10.5" x 21.25"	17 lbs	Sinfonia CS2 / Shinko Color Stream CS2 printer

UNIVERSAL PRINTER BAG AND CASE

MODEL	DIMENSIONS	WEIGHT	FITS
BRLUT1HW	17" x 26-39.75" x 16"	10 lbs	Universal Bag
FZPRINTER1HW	29.5" x 18" x 18.25"	44 lbs	Universal photo printer case

PHOTO BOOTH TRIPOD MOUNTING ADAPTERS

LATSA3



LATSA1



LATSA2

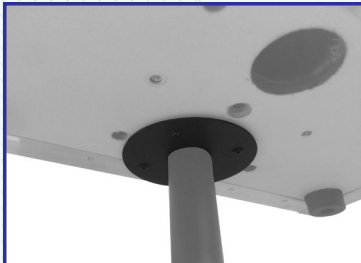

LATSA1WHT

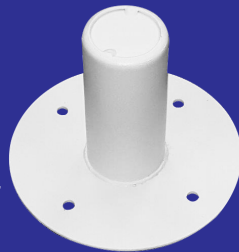

LATSA2WHT



MODEL	DIMENSIONS	WEIGHT	TYPE
LATSA3	4.5" x 3.5" x 4.5"	2 lbs	In speaker mount
LATSA1	8" x 3.25" x 4.5"	1 lbs	Surface mount
LATSA1WHT	8" x 3.25" x 4.5"	1 lbs	Surface mount
LATSA2	4.5" x 3.5" x 4.5"	1 lbs	In speaker mount
LATSA2WHT	4.5" x 3.5" x 4.5"	1 lbs	In speaker mount

PORTABLE BENCHES



BNCHWHT

The unique BNCH portable large bench is a convenient and comfortable accessory for photo booth setups as well as other applicable special events and gigs. Use as a piano bench, prop, or as decorative furniture at a trade show. The legs are completely removable for compact transport and storage. When assembled it's as sturdy as rock with its aluminum/steel frame. Available in two colors, black or white.



BNCH

DIMS: 41"W x 21.5"H x 13.5"D
WEIGHT: 26 LBS



DJCHAIRWHT

LUXE
ELEGANT MUSIC PRODUCTS

Another Odyssey product you can use at every gig. The adjustable DJ Chair allows you to sit back at a comfortable height while reducing fatigue and stress on your back and legs during those long gigs. The 5 adjustment levels, from 19" to 33", make you look cool without the appearance of sitting back on the job. Keep the seat up high so can lean on it while mixing or bring it down low and hide behind your rig in comfort. Holds up to 300 lbs. on its 12" circular foam padded seat. Features a removable back rest.

DIMS: 18" x 39" x 47.5" x 17"
WEIGHT: 35 LBS



DJCHAIR

19" DETACHABLE CABLE MANAGEMENT/ACCESSORY RACK BAR

ACG19

Easily detaches from rack rail attachments

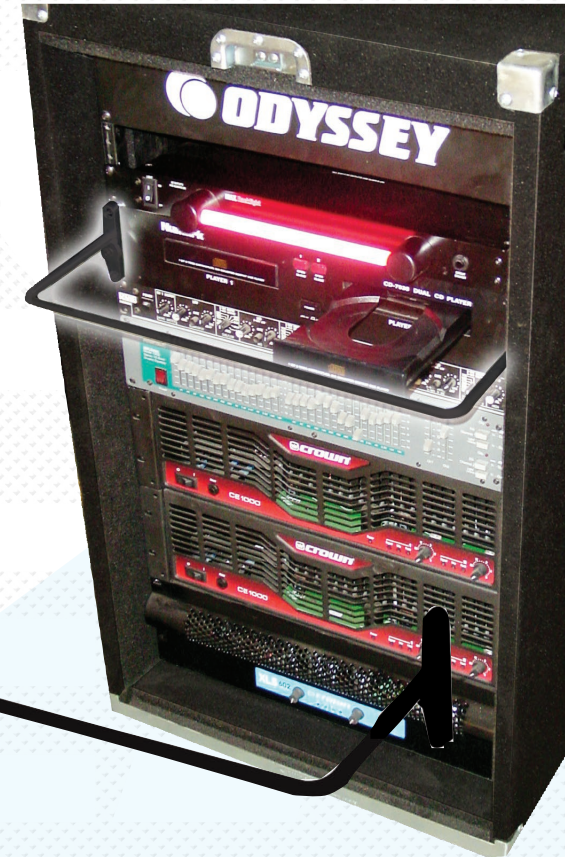

The ACG19 is an ingenious multipurpose detachable rack bar accessory. Great as a cable management lacing bar, it can also be used for hanging your headphones or other loose hanging DJ essentials.

Still have a rack mount dual CD player in your DJ arsenal? The ACG19 is a perfect CD Tray Guard. It works for all 19" dual rack mount CD players and will protect delicate open CD drawers from accidental damage during your gigs.

Features and Specs:

- Steel Construction
- Sleek Black Powder Coated Finish
- Convenient Easy Detachable and Attachable Locking Bar
- Width: 19"
- Depth: 6.5"
- Fits Standard Racks With 10/32" Pre-tapped Rack Screw Holes

RACK ACCESSORIES



AVAILABLE IN FOUR DIFFERENT SIZES. Solid steel black panels are great for covering empty rack space. Also useful for keeping long cables or other loose items inside the rack during transport.



This raised panel deters unauthorized persons from adjusting the covered gear. Large perforations allow visual confirmation of settings without removal while also allowing air flow.



FAN PANEL



AFAN45



ARPT1

BLANK PANELS

MODEL	DESCRIPTION
APB01	Blank Panel - 1U (1.75")
APB02	Blank Panel - 2U (3.50")
APB03	Blank Panel - 3U (5.25")
APB04	Blank Panel - 4U (7.00")

VENT SLOTTED PANELS

MODEL	DESCRIPTION
APV01	Vent Panel - 1U (1.75")
APV02	Vent Panel - 2U (3.50")
APV03	Vent Panel - 3U (5.25")

LARGE PERFORATED PANELS
ALLOWS MORE AIR FLOW

MODEL	DESCRIPTION
ARPVLP1	Perforated Panel - 1U (1.75")
ARPVLP2	Perforated Panel - 2U (3.50")
ARPVLP3	Perforated Panel - 3U (5.25")
ARPVLP4	Perforated Panel - 4U (7.00")

SECURITY PANELS

MODEL	DESCRIPTION
ARSCLP01	Perforated Panel - 1U (1.75")
ARSCLP02	Perforated Panel - 2U (3.50")
ARSCLP03	Perforated Panel - 3U (5.25")
ARSCLP04	Perforated Panel - 4U (7.00")

FAN PANELS

MODEL	DESCRIPTION
AFP01	3U (5.25") accommodates (1) AFAN45
AFP02	3U (5.25") accommodates (2) AFAN45
AFP03	3U (5.25") accommodates (3) AFAN45
AFAN45	4.5 Panel Mount Cooling Fan - 115 VAC (mounting screws not included) (includes AC cord)

RACK TRAY

MODEL	DESCRIPTION
ARPT1	1U TRAY SLIDES OUT 13.5" FROM RACK RAILS



Perfect for racking gear without rack ears. Especially well suited for studio & permanent installation. Use clamping rack shelves (below) for mounting non rack-mount gear in a rack that will be transported.



Rack Drawer with diced foam



ARTCA - 17" Tray Shelf Width



Comes in packages of 25, 50, or 100 Philip head rack screws and nylon washers.



Heavy-duty steel rack rails come standard 10/32" pre-tapped, ready for installation.

RACK SHELVES

MODEL	DESCRIPTION
ARS1	Rack Shelf - 1U (1.75") high, 10.50" deep
ARS2	Rack Shelf - 2U (3.50") high, 14.50" deep
ARS3	Rack Shelf - 3U (5.25") high, 14.50" deep
ARS4	Rack Shelf - 4U (7.00") high, 14.50" deep

CLAMPING RACK SHELVES

MODEL	DESCRIPTION
ASC2	2U (3.5") high, 14.5" deep with clamping mechanism
ASC3	3U (5.25") high, 14.5" deep with clamping mechanism
ASC4	4U (7") high, 14.5" deep with clamping mechanism

Front & rear clamps hold your no-rackable gear in place during transport. Slide the gear in and lower and tighten the two clamps.

RACK DRAWERS

These fully enclosed metal drawers are designed to mount directly into equipment rack rails. Comes equipped with a key lock to deter unwanted access.

MODEL	DESCRIPTION
ARDP02	2U (3.5")
ARDP03	3U (5.25")
ARDP04	4U (7")
ARDP05	5U (8.75")

MODEL	DESCRIPTION
ADFRD02	2U Drawer with dice foam
ADFRD03	3U Drawer with dice foam
ADFRD04	4U Drawer with dice foam
ADFRD05	5U Drawer with dice foam
ADFRDH	1U Thick Rack Drawer dice foam block

TOP MOUNT RACK SHELVES 10 U

MODEL	DESCRIPTION
ARTCA	Angled top-mount rackshelf
ARSTC	Flat top-mount rackshelf

RACK RAILS

MODEL	DESCRIPTION
ARR02	2U (3.5") pair of pre-taped rails
ARR04	4U (7") pair of pre-taped rails
ARR06	6U (10.5") pair of pre-taped rails
ARR08	8U (14") pair of pre-taped rails
ARR10	10U (17.5") pair of pre-taped rails
ARR12	12U (21) pair of pre-taped rails
ARR14	14U (24.5") pair of pre-taped rails
ARR16	16U (28") pair of pre-taped rails
ARR18	18U (31.5") pair of pre-taped rails

RACK RAIL SCREWS & WASHERS

MODEL	DESCRIPTION
ASW025	25 rack screws & washers
ASW050	50 rack screws & washers
ASW100	100 rack screws & washers

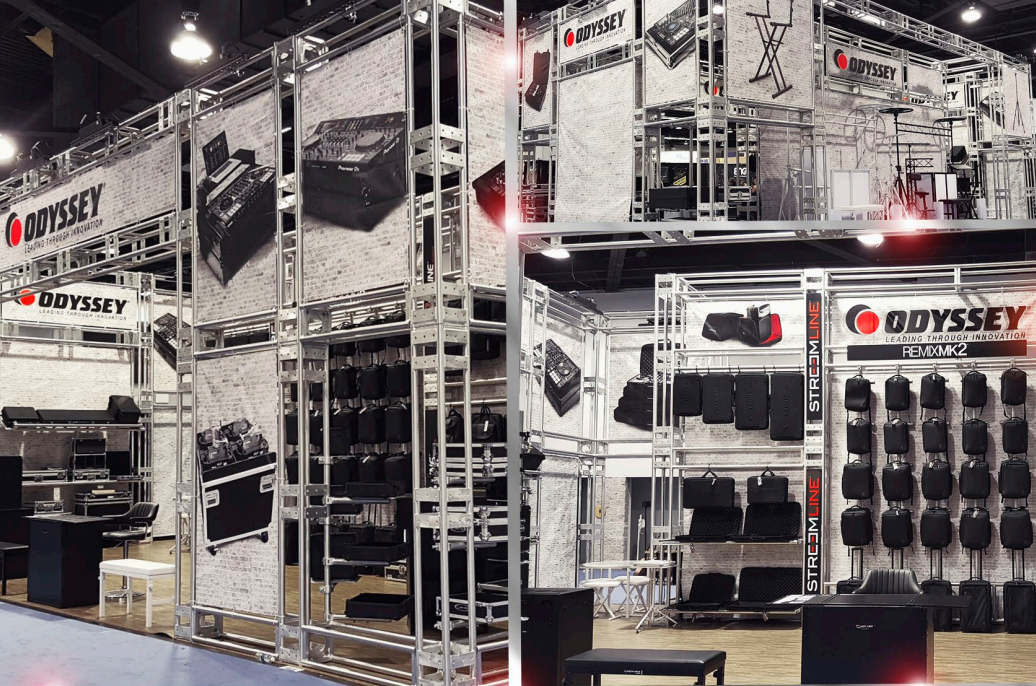

ODYSSEY
LEADING THROUGH INNOVATION

ODYUSA
INNOVATIVE DESIGNS

LUXE
ELEGANT MUSIC PRODUCTS

STREAMLINE
A NEW STANDARD IN ROBBLE MIXING

REMIXMK2
SERIES

SCRIMWERKS

Remixer™
SERIES

GS
Series
FOR DIGITAL DJ'S

2S
SHOW SOLUTIONS

FLIGHT FX

GENUINE GRÜV
GLIDE

LEVATION
THE ULTIMATE DJ GEAR STAND

BLACK KROM™

REDLINE
SERIES

Black Label
SERIES



DESIGNER DJ
SERIES

www.OdysseyGear.com

Odyssey Innovative Designs • 809 W. Santa Anita St., San Gabriel, CA 91776 • USA
Phone 626-588-2528 • Fax 626-588-2525